

FM6320 User Manual

V1.05



Table of contents

1	INTRODUCTION	6
1.1	ATTENTION	6
1.2	INSTRUCTIONS OF SAFETY	7
1.3	LEGAL NOTICE	7
1.4	ABOUT DOCUMENT	7
2	BASIC DESCRIPTION	8
2.1	PACKAGE CONTENTS	8
2.2	BASIC CHARACTERISTICS	8
2.3	MECHANICAL FEATURES	9
2.4	TECHNICAL INFORMATION ABOUT INTERNAL BATTERY!	10
2.5	ELECTRICAL CHARACTERISTICS	11
2.6	ABSOLUTE MAXIMUM RATINGS	12
3	CONNECTION AND PINOUT.....	13
3.1	SIM CARD INSERT SCHEME.....	13
3.2	INSTALLING FM6320 DRIVERS	15
3.3	NAVIGATE LED.....	16
3.4	STATUS LED	16
3.5	SOCKET 2×10 PINOUT	17
3.6	USB.....	18
4	FIRMWARE	18
4.1	UPDATING FIRMWARE USING USB CABLE	18
5	OPERATIONAL BASICS.....	19
5.1	OPERATIONAL PRINCIPLES.....	19
5.2	OPERATIONAL MODES	19
5.3	ACCELEROMETER	20
5.4	VIRTUAL ODOMETER	20
5.5	PROFILES.....	20
5.6	FEATURES.....	21
	<i>Scenarios.....</i>	<i>21</i>
	<i>Trip.....</i>	<i>21</i>
	<i>Geofencing.....</i>	<i>22</i>
	<i>iButton list</i>	<i>22</i>
6	CONFIGURATOR.....	22
6.1	STARTUP.....	22
6.2	CONFIGURATOR STRUCTURE.....	23
	<i>Buttons area</i>	<i>24</i>
	<i>Information area.....</i>	<i>25</i>
	<i>Profiles/global parameters selection area.....</i>	<i>25</i>
6.3	PARAMETERS CONFIGURATION	26
	<i>Global parameters Settings</i>	<i>26</i>
	<i>External Devices Settings.....</i>	<i>27</i>
	<i>Settings and configurable parameters menu</i>	<i>28</i>
	6.3.1.1 System Settings	28
	6.3.1.2 GSM Settings	29
	6.3.1.2.1 GPRS.....	29
	6.3.1.2.2 Data limits functionality.....	30
	6.3.1.2.3 SMS Security	30
	6.3.1.2.4 Operator List	32
	6.3.1.2.5 SMS Events.....	33
	6.3.1.3 Features	34
	6.3.1.3.1 sMode	34
	6.3.1.3.2 Scenarios.....	35

6.3.1.3.3	Trip	35
6.3.1.3.4	Geofencing	36
6.3.1.3.4.1	Geofencing settings	36
6.3.1.3.4.2	AutoGeofencing settings	37
6.3.1.3.5	iButton List	38
6.3.1.4	CAN	39
6.3.1.4.1	CAN interface parameters	39
6.3.1.5	I/O	44
6.3.1.5.1	FM6320 available I/O list	44
6.3.1.5.2	I/O configuring	47
6.3.1.5.3	I/O properties	48
6.3.1.6	K Line parameters	51
6.3.1.7	Configurable parameter values and Global parameter values	54
6.3.1.7.1	Configurable parameters	54
6.3.1.7.2	Global and External devices parameters	64
7	PROFILE SWITCHING	65
7.1	PROFILE SWITCHING DEPENDENCE ON GSM OPERATOR	66
7.2	PROFILE SWITCHING DEPENDENCE ON I/O EVENT	68
	<i>Example #1</i>	68
	<i>Example #2</i>	69
8	DATA ACQUISITION	69
8.1	GPS DATA ACQUISITION	69
	<i>Min. Period</i>	70
	<i>Min. Distance</i>	70
	<i>Min. Angle</i>	71
	<i>Min. Speed</i>	71
8.2	I/O DATA ACQUISITION	71
	<i>Configuration</i>	72
	<i>Event generation</i>	72
9	DEEP SLEEP MODE	73
10	FEATURES AND SCENARIOS	74
10.1	ECO DRIVING/GREEN DRIVING SCENARIOS	74
	<i>Mounting Requirements</i>	75
	<i>Configuration</i>	77
	<i>Data output</i>	78
10.2	OVERSPEEDING SCENARIO	78
	<i>Mounting Requirements and Working Conditions</i>	78
	<i>Configuration</i>	78
10.3	IMMOBILIZER/ AUTHORIZED DRIVING SCENARIO	78
	<i>Configuration</i>	79
	<i>Configuration</i>	79
10.4	COM1 AND COM2 WORKING MODES	80
	<i>Silent Mode</i>	80
	<i>FM Log Mode</i>	80
	<i>LLS Mode</i>	80
	10.4.1.1 LLS Mode Configuration	80
	<i>LCD Mode Configuration</i>	80
	<i>RFID HID Mode Configuration</i>	80
	<i>RFID MF7 Mode Configuration</i>	81
	<i>Garmin Mode Configuration</i>	81
	10.4.1.2 Settings	81
	10.4.1.3 Firmware Configuration	81
	<i>COM TCP Link Mode</i>	82
	<i>TCP Link Mode (Binary)</i>	82
	<i>NMEA Log Mode</i>	82
11	SMS COMMAND LIST	83

11.1	GETSTATUS	84
11.2	GETWEEKTIME	85
11.3	GETOPS	85
11.4	READOPS#	85
11.5	GETNMEAINFO.....	85
11.6	GETCFGTIME	86
11.7	GETGPS	86
11.8	LOADPROFILE#	86
11.9	CPURESET	86
11.10	RESETALLPROF	86
11.11	GETVER	87
11.12	GETIO.....	87
11.13	GETINFO	87
11.14	DELETERECORDS.....	88
11.15	READIO #.....	88
11.16	SETDIGOUT ##### X Y Z W.....	88
11.17	GETPARAM #####	88
11.18	SETPARAM ##### #.....	88
11.19	FLUSH #,#,#,#,#,#.....	89
11.20	GETGNSS	89
11.21	SN X.....	90
11.22	BANLIST	90
11.23	CRASHLOG	90
11.24	BRAMINFO	90
11.25	ODINFO	91
12	CAN	92
12.1	GENERAL DESCRIPTION.....	92
12.2	CONFIGURATION.....	93
12.3	EXAMPLE.....	94
12.4	AUTOCAN DESCRIPTION	96
	<i>Configuration</i>	97
	<i>CAN monitoring</i>	98
	<i>Offline configuration</i>	99
	<i>AutoCAN ID list</i>	99
13	USING TACHOGRAPH	101
14	RFID	105
15	GARMIN	106
15.1	SUPPORTED GARMIN FMI PROTOCOLS	107
	<i>Standard protocols</i>	107
	<i>Enhanced protocols</i>	108
15.2	SUPPORTED FEATURES ON TAVL CLIENT APPLICATION	108
15.3	TEXT MESSAGING	108
15.4	DESTINATION MESSAGE.....	108
15.5	ETA REQUEST MESSAGE	109
15.6	CONNECTION AND PINOUT.....	109
16	LLS SENSOR	110
16.1	SPECIFICATIONS	111
16.2	HARDWARE	111
16.3	CONNECTING LLS TO FM6320	111
17	GPRS COMMANDS	112
18	DEBUG MODE.....	114
19	FM6320 REMOTE LOG	115

1 INTRODUCTION

1.1 Attention



Do not disassemble the device. If the device is damaged, the power supply cables are not isolated or the isolation is damaged, before unplugging the power supply, do not touch the device.



All wireless data transferring devices produce interference that may affect other devices which are placed nearby.



The device must be connected only by qualified personnel.



The device must be firmly fastened in the predefined location.



The programming must be performed using a second class PC (with autonomic power supply).



The device is susceptible to water and humidity.



Any installation and/or handling during a lightning storm are prohibited.



FM6320 has USB interface;
Please use cables provided with FM6320 device.
Teltonika is not responsible for any harm caused by using wrong cables for PC <-> FM6320 connection.



This sign on the packaging means that the electric and electronic equipment to be utilized must be stored separately.

1.2 Instructions of safety

This chapter contains information on how to operate FM6320 safely. By following these requirements and recommendations, you will avoid dangerous situations. You must read these instructions carefully and follow them strictly before operating the device!

To avoid mechanical damage, it is advised to transport the FM6320 device in an impact-proof package. Before usage, the device should be placed so that its LED indicators are visible, which show the status of operation the device is in.

When connecting the connection (2x10) cables to the vehicle, the appropriate jumpers of the power supply of the vehicle should be disconnected.

Before dismounting the device from the vehicle, the 2x10 connection must be disconnected.

The device is designed to be mounted in a zone of limited access, which is inaccessible for the operator. All related devices must meet the requirements of standard EN 60950-1.

The device FM6320 is not designed as a navigational device for boats.

1.3 Legal Notice

Copyright © 2014 Teltonika. All rights reserved. Reproduction, transfer, distribution or storage of part or all of the contents in this document in any form without the prior written permission of Teltonika is prohibited.

Garmin and the Garmin logo are registered trademarks, all rights reserved.

Other products and company names mentioned here may be trademarks or trade names of their respective owners.

1.4 About document

This document contains information about the architecture, possibilities, mechanical characteristics, and configuration of the FM6320 device.

Acronyms and terms used in document:

PC – Personal Computer

GPRS – General Packet Radio Service

GPS – Global Positioning System

GSM – Global System for Mobile Communications

SMS – Short Message Service

AC/DC – Alternating Current/Direct Current

I/O – Input/Output.

Record – AVL data stored in FM6320 memory. AVL data contains GPS and I/O information

AVL packet - Data packet that is being sent to server during data transmission. AVL packet contains from 1 to 50 records.

Geofence – a virtual geographic area of interest that can be defined by a radius or polygon for the location. In this document term “Geofence” is often used as functionality, which generates an event when crossing a defined area.

2 BASIC DESCRIPTION

FM6320 is a terminal with GPS and GSM/3G connectivity, which is able to determine the object's coordinates and transfer them via the GSM/3G network. This device is perfectly suitable for applications, which need location acquirement of remote objects. It is important to mention that FM6320 has additional inputs and outputs, which let you control and monitor other devices on remote objects. FM6320 also has a USB port for device status log output and entering configurations.

2.1 Package contents¹

Usually the FM6320 device sample is supplied to the customer in a cardboard box containing all the equipment that is necessary for operation. The package contains:

- FM6320 device
- Input and output power supply cable with 2x10 connection pins
- 4 screws for assembling device
- GPS/GLONASS antenna
- GSM antenna
- USB cable
- Port 1/2 cable
- Port 3 cable

2.2 Basic characteristics

GSM/GPRS/3G features:

- Telit HE910-D 5-band module (GSM 850 / 900 / 1700 / 1900 / 2100 MHz);
- EGPRS class 33;
- SMS (text, data).

GNSS TG3300 Module features:

- Navigation Systems; GPS/GLONASS;
- Protocol NMEA-0183: GGA, GGL, GSA, GSV, RMC, VTG;
- Up to -162 dBm sensitivity.

Hardware features:

- STM32 processor;
- 1 MB internal Flash memory;
- External memory card slot;
- Built-in accelerometer.
- Internal backup battery included

Interface features:

- Power supply: 10 ÷ 30V;
- USB port;

¹ Package content depends on Order Code, and can be customized by customer needs.

- 4 digital inputs;
- 2 analog inputs;
- 4 open collector digital outputs;
- 4 1Wire® temperature sensor;
- 1Wire® iButton;
- LEDs indicating device status;
- 2xRS232 port;
- RS485 port;
- J1708 interface;
- LVCAN interface;
- CAN messages 2.0 A, B Active support. Speed up to 1 Mbit/s.
- Roaming enabling/disabling;
- Offline working mode;
- Records importing using USB/microSD card;
- Remote logs reading via SMS/GPRS;

2.3 Mechanical features

Table 1 FM6320 physical interfaces and operation environment

Part name	Physical specification	Operation environment
Navigation LED	LED	Operation temperature: -25°C ... +55°C Storage temperature: -40°C ... +70°C Storage relative humidity 5 ... 95 % (non condensating)
Modem LED	LED	
GPS	GPS antenna connector SMA	
GSM	GSM antenna connector SMA female outer shell, female inner pin	
Socket 2x10	Tyco Micro MATE-N-LOK™ or similar	
USB	Mini USB socket	
Port1	RS232 or RS485 port channel 1 (RJ45 socket)	
Port2	RS232 port channel 1 (RJ45 socket)	
J1708	J1708 port channel	

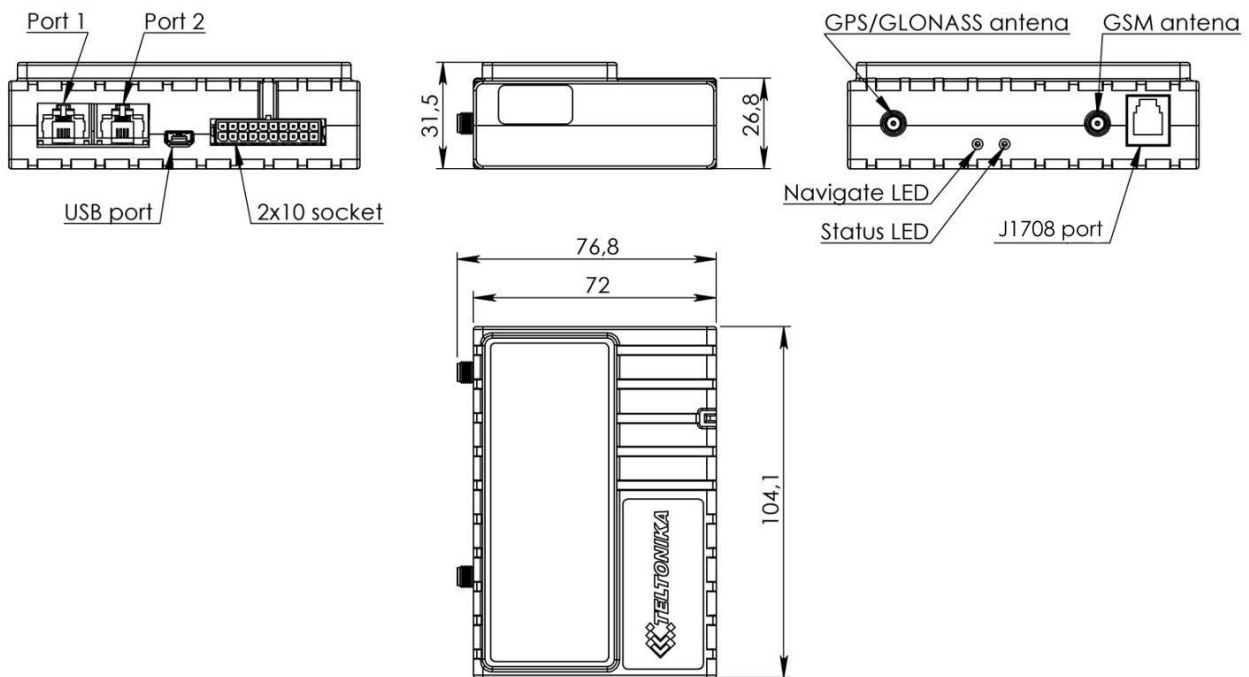

Figure 1 FM6320 view & dimensions in mm (tolerance ± 2 mm)

2.4 Technical Information about internal battery!

Ni-MH Rechargeable battery, 8.4V, 550 mA.

FM6320 operating time with internal backup battery depends on temperature, data sending frequency (SMS and GPRS), and accumulator age, number of charge/discharge cycles.

For example:

- In sleep mode a new FM6320 device, operating time approximately 15 hours
- In deep sleep mode – 137 hours
- Operating time for a new FM6320 device, working in normal mode (records are being acquired every 10 sec. and sent in packets of 4 records every 60 sec.), is approximately 2 h 30 min.

2.5 Electrical characteristics

Table 2 Electrical characteristics

CHARACTERISTIC DESCRIPTION	VALUE			
	Min.	Typ.	Max.	Unit
SUPPLY VOLTAGE				
Supply Voltage (Recommended Operating Conditions)	11.8	-	30	V
Supply Voltage (for internal rechargeable battery charging proper functioning)	11.8	-	30	V
POWER SUPPLY CURRENT (HARDWARE VERSION WITH INTERNAL BATTERY)				
Deep Sleep, average, I _{cc.ds}	-	2.5	4	mA
Sleep, average, I _{cc.ds} , V _{cc} =12V	-	35	-	mA
Sleep, average, I _{cc.ds} , V _{cc} =24V	-	20	-	mA
U _{cc} =12.6V, all modules fully working, internal battery is charging, I _{cc1}	-	-	350	mA
U _{cc} =12.6V, all modules fully working, internal battery is charged, I _{cc2}	-	-	300	mA
U _{cc} =25.2V, all modules fully working, internal battery is charging, I _{cc3}	-	-	195	mA
U _{cc} =25.2V, all modules fully working, internal battery is charged, I _{cc4}	-	-	140	mA
DIGITAL OUTPUT (OPEN DRAIN GRADE)				
Drain current (Digital Output OFF)	-	-	120	µA
Drain current (Digital Output ON, Recommended Operating Conditions)	-	-	300	mA
Static Drain-Source resistance (Digital Output ON)	-	-	300	mOhm
DIGITAL INPUTS				
Input resistance (DIN1, DIN2, DIN3)	15	-	-	kOhm
Input Voltage (Recommended Operating Conditions)	0	-	Supply voltage	V
Input Voltage threshold (DIN1)	-	7,5	-	V
Input Voltage threshold (DIN2, DIN3, DIN4)	-	2,5	-	V
ANALOG INPUTS				
Input Voltage (Recommended Operating Conditions), Range1	0	-	10	V
Input resistance, Range1	-	120	-	kOhm
Input Voltage (Recommended Operating Conditions) Range2	0	-	30	V

CHARACTERISTIC DESCRIPTION	VALUE			
	Min.	Typ.	Max.	Unit
Input resistance, Range2	-	147	-	kOhm
OUTPUT SUPPLY VOLTAGE 1-WIRE²				
Supply Voltage	3,3	-	3,9	V
Output inner resistance	-	7	-	Ohm
Output current ($U_{out} > 3.0V$)	-	30	-	mA
Short circuit current ($U_{out} = 0$)	-	130	-	mA
CAN INTERFACE				
Internal terminal resistors CAN bus	-	120	-	Ohm
Differential input resistance	19	30	52	kOhm
Recessive output voltage	2	2.5	3	V
Differential receiver threshold Voltage	0.5	0.7	0.9	V
Common mode input voltage	-30	-	30	V



When connecting a COM port to an active external device keep in mind that the first power supply must be connected to FM6320, and then the external device should be powered. Connecting external devices when FM6320 is powered off is not recommended.

2.6 Absolute Maximum Ratings

Table 3 Absolute maximum ratings

CHARACTERISTIC DESCRIPTION	VALUE			
	Min.	Typ.	Max.	Unit
Supply Voltage (Absolute Maximum Ratings)	-32		32	V
Digital output clamp threshold voltage (Absolute Maximum Ratings), ($I_{drain} = 2mA$)	36			V
Digital Input Voltage (Absolute Maximum Ratings)	-32		32	V
Analog Input Voltage (Absolute Maximum Ratings)	-32		32	V
Voltage on Supply Voltage 1-Wire (Absolute Maximum Ratings)	0		10	V
Voltage on Data Input/Output 1-Wire (Absolute Maximum Ratings)	0		10	V
Voltage on CANH, CANL (Absolute Maximum Ratings)	-58		58	V

² 1-wire Supply voltage PIN is dedicated for 1-wire devices ONLY, do not use it for any other purpose.

3 CONNECTION AND PINOUT

3.1 SIM card insert scheme

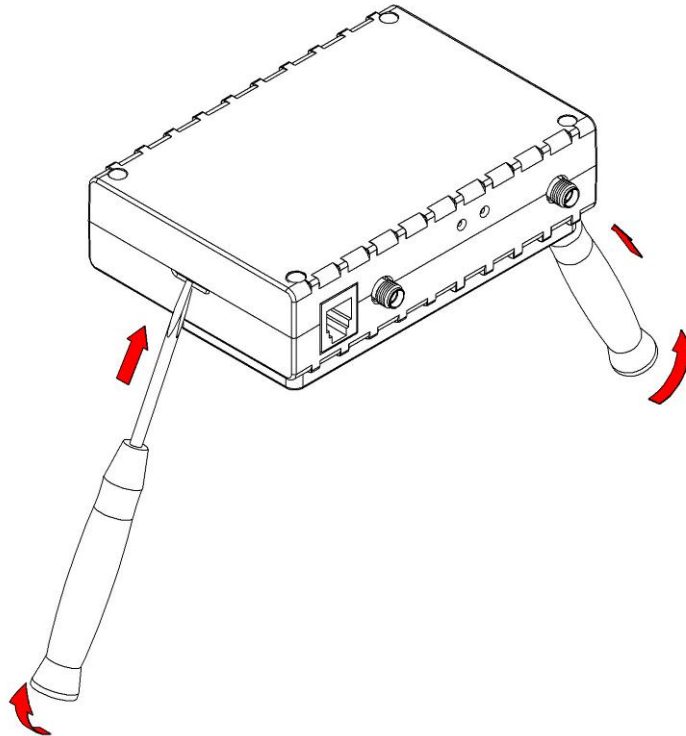

①

Gently open FM6320 case using screwdrivers

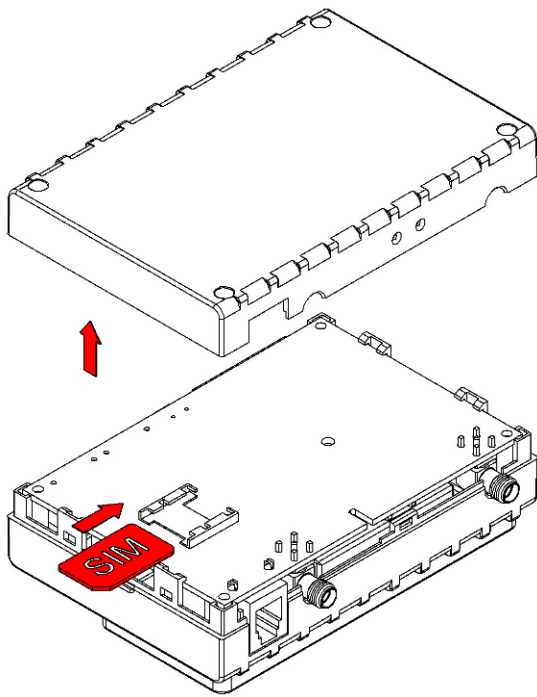

②

Take off FM6320 case and insert SIM card as shown

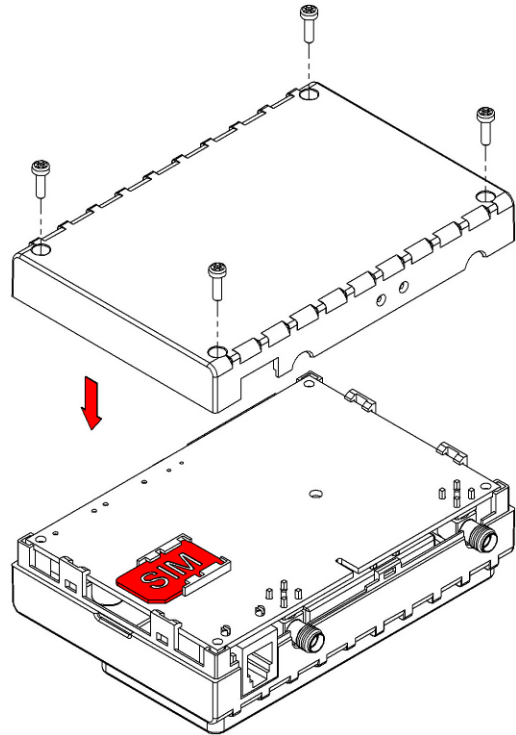

③

Assemble device as shown and put screws into the holes

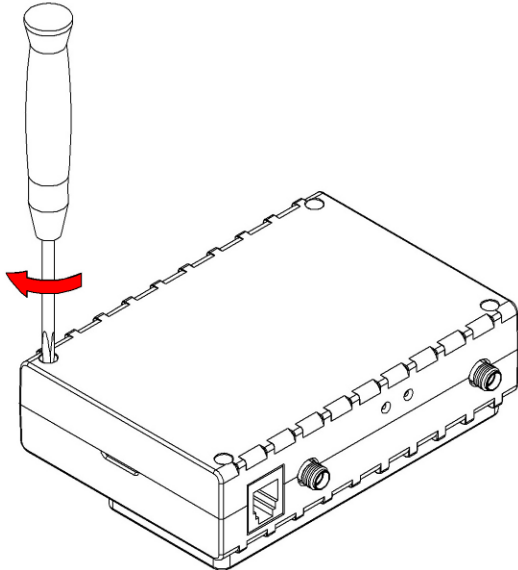

④

Screw all 4 screws

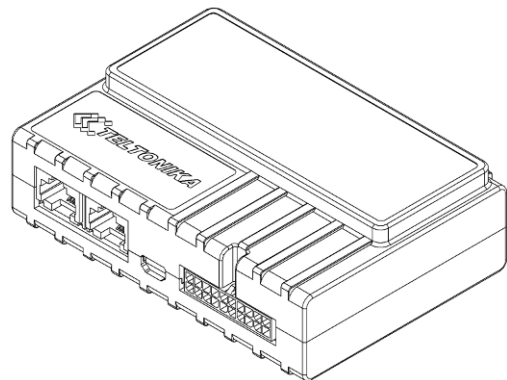

⑤

Device is ready

3.2 Installing FM6320 drivers

Software requirements

- Operating system 32-bit and 64-bit: Windows XP with SP3 or later, Windows Vista, Windows 7.
- MS .NET Framework V3.5 or later (<http://www.microsoft.com>).

Drivers

Please download Virtual COM Port drivers from Teltonika website: http://avl1.teltonika.lt/downloads/FM63/vcpdriver_v1.3.1_setup.zip

Installing drivers

Extract and run VCPDriver_V1.3.1_Setup.exe. This driver is used to detect FM6320 device connected to the computer. Click 'Next' in driver installation window (figures below):

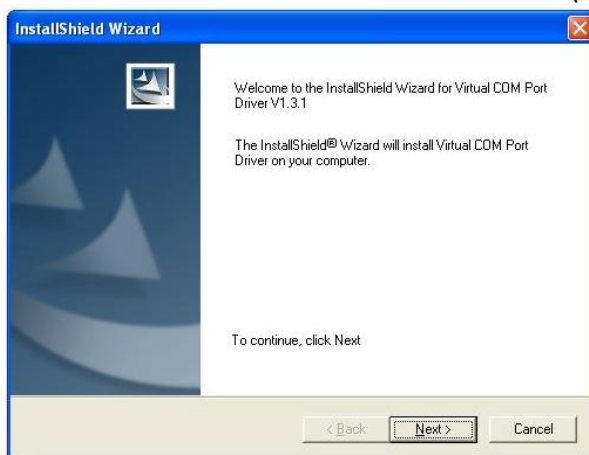

Figure 2 Driver installation window

This will launch the device driver installation wizard. In the following window click 'Next' button again:



Figure 3 Driver installation window

Setup will continue installing drivers and will display a window about successful process in the end. Click 'Finish' to complete setup:



Figure 4 Driver installation window

You have now installed drivers for FM6320 device successfully.

3.3 Navigate LED

Table 4 Navigate LED operation

Behaviour	Meaning
Permanently switched on	GPS signal is not received
Blinking every second	Normal mode, GPS is working
Off	GPS is turned off because: <ul style="list-style-type: none"> • Deep sleep mode Or <ul style="list-style-type: none"> • GPS antenna short circuited

3.4 Status LED

Table 5 Status LED Operation

Behaviour	Meaning
Blinking every second	Normal mode
Blinking every 2 seconds	Deep sleep mode
Blinking fast for a short time	Modem activity
Blinking fast constantly	Boot mode
Off	<ul style="list-style-type: none"> • Device is not working Or <ul style="list-style-type: none"> • Device firmware being flashed

3.5 Socket 2x10 pinout

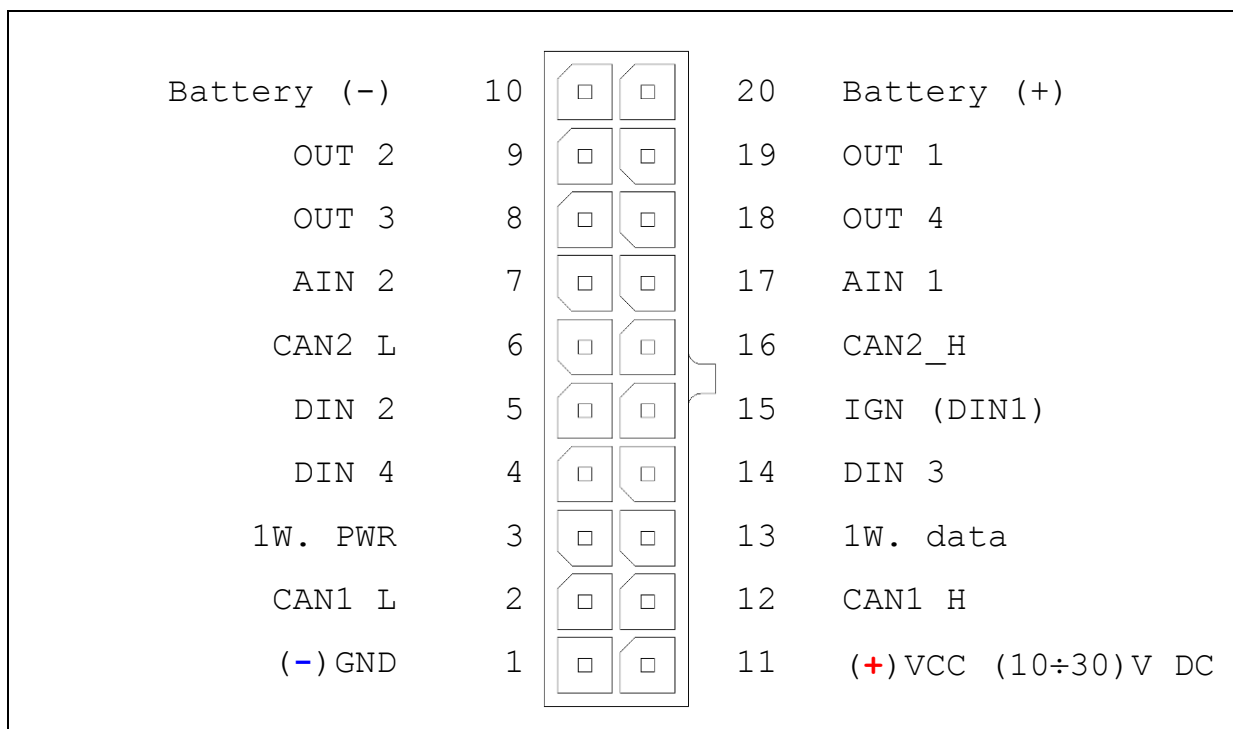

Figure 5 2x10 socket pinout

Table 6 2x10 SOCKET PINOUT DESCRIPTION

Pin Nr.	Pin Name	Description
1	(-)GND	(-) Ground pin. (10...30) V DC*
2	CAN1 L	SAE J1939 CAN interface Low channel 1
3	1W. PWR	Power supply pin for Dallas 1-Wire® devices
4	DIN 4	Digital input. Channel 4
5	DIN 2	Digital input. Channel 2
6	CAN2 L	SAE J1939 CAN interface Low channel 2
7	AIN 2	Analog input, channel 2. Input range: 0 - 30V/ 0 - 10V DC
8	OUT 3	Digital output. Channel 3. Open collector output
9	OUT 2	Digital output. Channel 2. Open collector output
10	Battery (-)	-
11	(+)VCC (10...30) V DC	Power supply pin
12	CAN1 H	SAE J1939 CAN interface High channel 1
13	1W. data	Data channel for Dallas 1-Wire® devices
14	DIN 3	Digital input, channel 3
15	DIN 1	Digital input, channel 1 (RESERVED FOR IGNITION LINE)
16	CAN2 H	SAE J1939 CAN interface High channel 2
17	AIN 1	Analog input, channel 1. Input range: 0 - 30V/ 0 - 10V DC
18	OUT 4	Digital output. Channel 4. Open collector output
19	OUT 1	Digital output. Channel 1. Open collector output
20	Battery (+)	-

3.6 USB

When FM6320 is connected to a PC it creates a STM Virtual COM Port, which can be used as a system port (to flash firmware and configure the device).

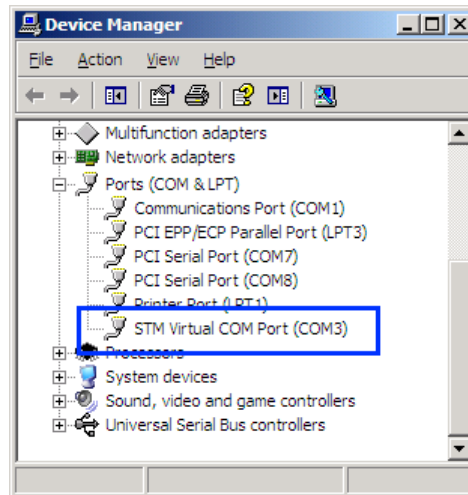

Figure 6 COM-Ports

4 FIRMWARE

4.1 Updating firmware using USB cable

FM6320 functionality is always improving, new firmware versions are developed. Current module firmware version can be retrieved from configurator. See configuration description for details.

Contact sales manager to get the latest firmware.

Connect FM6320 to PC with USB cable. Launch “Firmware Updater”, select COM port, click connect and update. Update process may take up to several minutes.

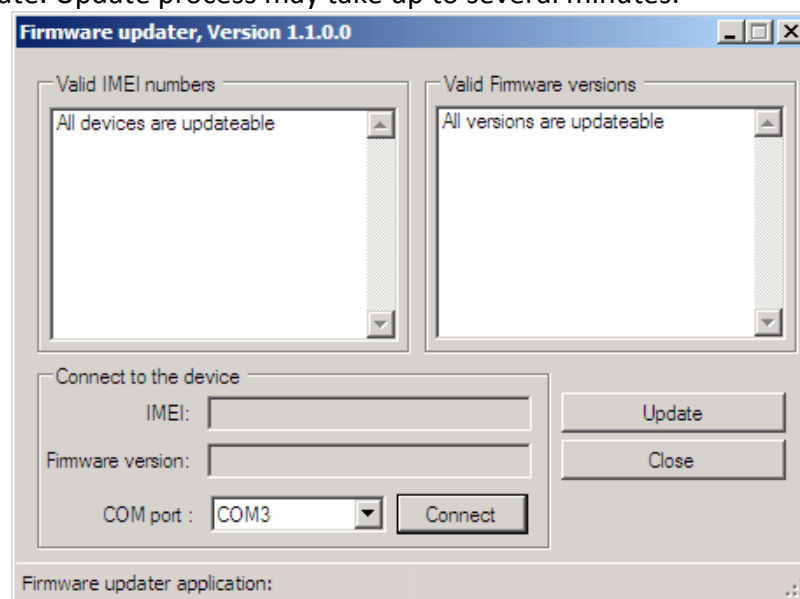

Figure 7 FM updater screen

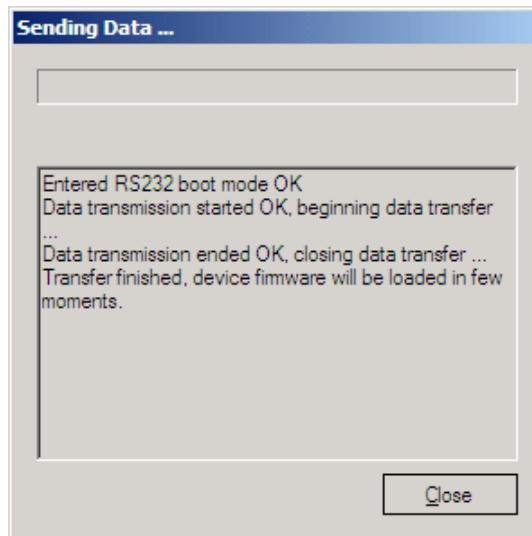

Figure 8 FM firmware updating finished

5 OPERATIONAL BASICS

5.1 Operational principles

FM6320 module is designed to acquire records and send them to server. Records contain GPS and I/O information. Module uses GPS receiver to acquire GPS data and is powered with 3 data acquire methods: time-based, distance-based and angle-based. Method's details are described in Data Acquisition chapter 8. All data is stored in flash memory and later can be sent via GPRS/3G or SMS channels. GPRS/3G mode is the most preferred data sending mode. SMS mode is mostly used in areas without GPRS/3G coverage or when GPRS usage is too expensive.

GPRS/3G and SMS settings are described in chapters 6.3.1.2.1 and 6.3.1.2.3. FM6320 communicates with server using special data protocol. Data protocol is described in device protocols documentation. Please contact Teltonika sale manager to find out more about protocols documentation purchase.

FM6320 can be managed by SMS commands (SMS Command list is described in SMS Command List section) and GPRS commands (GPRS Command list is described in GPRS Command List section). Module configuration can be performed over TCP or via SMS. Configuration parameters and modes are described in device protocols documentation.

5.2 Operational Modes

FM6320 is designed to operate in two different modes: Normal Mode and Deep Sleep Mode (Standby mode). Normal Mode means that FM6320 is fully functional and performs all the functionality mentioned above in Operational principals section.

Deep Sleep Mode is designed to dramatically reduce power consumption. It is a separate mode and certain conditions must be fulfilled to switch from Normal operation and enter this mode. Detailed information about how FM6320 enters/exits Deep Sleep Mode and what functions does FM6320 perform while in this mode can be found in chapter 9.

5.3 Accelerometer

FM6320 has a built in 3 axis accelerometer which allows the device to indicate if vehicle is moving or not, as well as measure acceleration. Accelerometer sensitivity can be configured – it has 2 configurable global parameters: start and stop timeouts that define time intervals in seconds. To indicate that a vehicle is moving, FM6320 constantly (in frequency of 50 Hz) checks for g force change on X, Y and Z axes. If measured g force keeps exceeding the set limit (it is not configurable) for defined time interval in “Movement Filter Start” field (Figure 10), then the vehicle is considered as moving. Same settings for idle indication apply – if g force change is less than the set limit for time interval defined in “Movement Filter Stop” field then the vehicle is considered as idle (not moving).

Example for default parameters: Movement Filter Start = 1 and Movement Filter Stop = 30 means that movement will be detected after 1 second and stop will be detected after 30 seconds of inactivity.



Figure 9 Accelerometer settings

5.4 Virtual Odometer

Virtual odometer is used to calculate travelled distance in FM6320 as a separate I/O element. When FM6320 detects movement, it starts counting distance using GPS signal: every second it checks current location and calculates distance between current and previous point. It keeps adding these intervals until it is time to make a record, then FM6320 records its location and adds odometer value, which is equal to the sum of all distances, measured every second. When record is made, odometer resets to zero and distance calculation starts all over again.

Virtual odometer as an I/O element can be also used with Trip feature, read chapter 0.

5.5 Profiles

FM6320 has 4 profiles saved in Flash memory of the module. Every profile has a list of parameters, which enables FM6320 to operate in different modes while using different profiles. The easiest way to understand what is a profile is to compare it to a list of instructions that are written for different cases. You are allowed to setup up to 4 different module behaviours. Global parameters contain settings that are common for all 4 profiles. This means that if FM6320 is set to call to predefined number, you will be able to call it while using any profile.

Profile 3 is default profile for FM6320. It is always loaded on the very first start-up and further profile switching is proceeded after operator scan or I/O element changes.

Switching between profiles (changing behaviour) can be performed by GSM Operator (mostly used for roaming applications), or by Profile switching depending on I/O Event (on I/O value changing). More information about Profile switching functionalities can be found in chapters 7.1 (Switching by GSM Operator) and 7.2 (Switching by I/O Element).

5.6 Features

Using available features can greatly increase FM6320 usability options.

Scenarios

Four scenarios are available on FM6320 device:

- a. Any Digital Output is used by scenarios: Authorized Driving/ Immobilizer, ECO driving/Green driving and Over speeding.
- b. Excessive idling don't use Digital Output

ECO driving/Green driving Scenario. Gives the ability to periodically monitor driving characteristics and warn the driver against over accelerating, braking or cornering. More about ECO driving/Green driving read in chapter 10.1

Over Speeding Scenario. Helps to prevent from exceeding fixed speed and inspects driver if needed. Any DOUT (which is configured) is controlled by scenario for user needs, to manage buzzer, LED etc.

Authorized Driving Scenario. Gives ability to use vehicle for 500 specific iButton owners (specified in iButton list). Any DOUT (which is configured) is controlled by scenario for user needs, to manage buzzer, LED etc.

Immobilizer Scenario. Vehicle can be used only if iButton is connected. In this scenario iButton list is not used - connect any iButton to pass Immobilizer security. Any DOUT (which is configured) is controlled by scenario for user needs. DOUTX is continuously OFF. DOUTX turns ON if Ignition turns ON (Din1=1). After iButton ID is read (any iButton is attached), DOUTX turns OFF. After iButton identification DIN1 (ignition) can be turned OFF (Din1=0) for no longer than 30 seconds, otherwise immobilizer must be repeated.

Excessive idling. If ignition (DIN1 or Power Voltage) is on and vehicle is not moving, FM6300 after configured time period generate event. When vehicle starts moving FM6300 after configured time period generate event that vehicle idle time ends.



Note: Authorized Driving and Immobilizer Scenarios are combined into a single scenario.



Note: All scenarios can be activated at the same time and one DOUT can control all scenarios.

Trip

Trip customizable feature enables user extended monitoring of performed trips (from engine start at present location to engine stop at arrived location), log their start and stop points, view driven total distance. Event will be **generated (included into send records) only** when trip starts and finishes.

Geofencing

Geofencing is another feature which is highly customizable and can detect wherever a car enters or leaves customized areas. More about Geofencing can be read in chapter 6.3.1.3.4 .

Auto Geofencing feature, if enabled, is activated automatically by turning off car ignition. Next time before driving user has to disable Auto Geofencing with iButton or by turning on car ignition. In case of theft, the car leaves Auto Geofencing zone without authorization and FM6320 device automatically sends high priority record to AVL application.

iButton list

iButton list is used to enter authorized iButton ID codes, which are used to authenticate driver in Authorized driving and Auto Geofencing options.

6 CONFIGURATOR

6.1 STARTUP

FM6320 configuration is performed via FM6320 Configurator program. FM6320 Configurator can be downloaded from <http://av1.teltonika.lt/downloads/FM63/>. Contact sales manager to get the latest FM6320 Configurator version. FM6320 configurator operates on Microsoft Windows OS and uses MS .Net Framework 3.5 or higher. Please ensure that MS .Net Framework 3.5 or later is installed on your PC before starting configurator. Latest MS .Net Framework version can be downloaded from official Microsoft web page.

Module configuration is performed over USB cable or COM2. Configuration process starts from starting FM6320 Configurator program and then connecting to FM6320 device via "Connect" button located on the top left corner of configurator. If one of the communication sources (USB cable or COM2) is connected to the device, the configurator will detect it automatically and if connected successfully IMEI, Version fields, which were empty, now are filled with certain numbers depending on Modem IMEI and firmware version of your device (Figure 10).

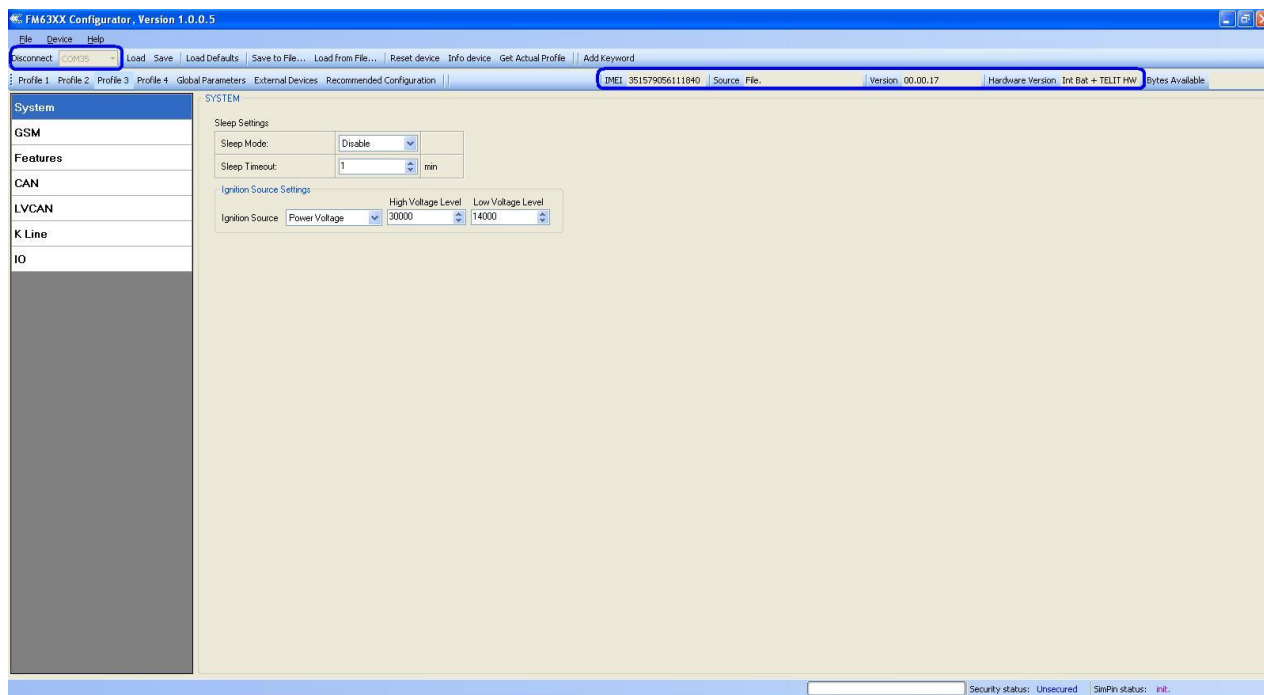

Figure 10 FM6320 Configurator window

6.2 Configurator structure

FM6320 has four user editable profiles, which can be both loaded and saved to the device. User can also revert to default settings, by pressing Load Defaults button. Any modification of configuration settings has to be saved to FM6320 device, otherwise it will not be written to device flash memory.

FM6320 Configurator is divided into 5 main areas (Figure 11):

- a. Buttons area;
- b. Information area;
- c. Profiles or global parameters selection area;
- d. Settings menu;
- e. Configurable parameters and values menu.

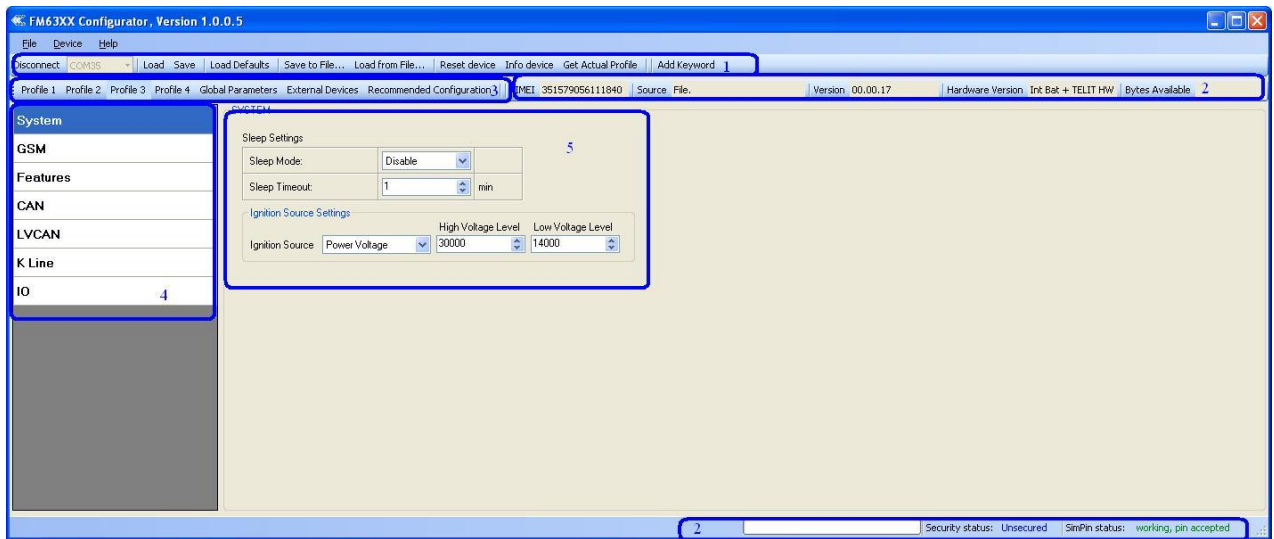

Figure 11 FM6320 Configurator window structure

Buttons area

Table 7 Configurator buttons area description

Main Buttons	
Button	Description
<i>Connect</i>	connects the device
<i>Load</i>	reads configuration parameters from FM6320 Flash memory
<i>Save</i>	saves configuration parameters to FM6320 Flash memory
<i>Load Defaults</i>	loads default FM6320 settings that later can be modified
<i>Save to File...</i>	allows user to save currently entered settings to .XML file for later usage
<i>Load from File...</i>	allows user to load configuration saved in .XML extension file
<i>Reset device</i>	reboots FM6320 and displays processor firmware version
<i>Info device</i>	allows user to see actual device I/O's information
<i>Get Actual Profile</i>	Informs user about active profile
Additional Buttons	
Button	Description
<i>SIM PIN</i>	allows to enter PIN code if inserted SIM card has activated PIN code security
<i>Add Keyword³ / Change Keyword / Switch Security Off</i>	buttons are used to protect configurator from unauthorized access to configuration

³ Keyword is of 4 - 10 symbol length (Latin text and/or numbers). If a keyword is set, every time user reconnects FM6320 to USB or COM2 port he will be asked to enter a valid keyword when connecting FM6320 to configurator. User is given 5 attempts to enter a valid keyword before blocking the configurator.

Information area

FM6320 information area is divided into 2 parts located on the top right and bottom of the configurator. When configurator is connected to the device via USB or COM2 port all necessary information about the device is shown here:

- IMEI – unique number for every FM6320 and usually servers recognize different devices by this number;
- SOURCE – configuration source (device or file);
- VERSION – firmware version of the device;
- HARDWARE VERSION – hardware version of the device;
- STATUS – status bar;
- SECURITY STATUS – status of the configurator security;
- SIM PIN STATUS – status of SIM card in the device;

Profiles/global parameters selection area

FM6320 has 4 user editable profiles stored in Flash no. 1-4 memories and one extra profile stored in Flash no. 0 which cannot be edited by user. Profile from Flash no. 0 is used by system and cannot be selected as active, while profiles from Flash no. 1-4 are fully editable and can be selected as active.

Reading profiles, Global parameters and External Devices from Flash memory is a very simple procedure. By pressing “Load” button all 4 profiles, Global parameters and External Devices are loaded to the configurator (Figure 12). To configure 3rd profile choose the TAB named “Profile 3” and all configurable parameters of this profile will be available to change.

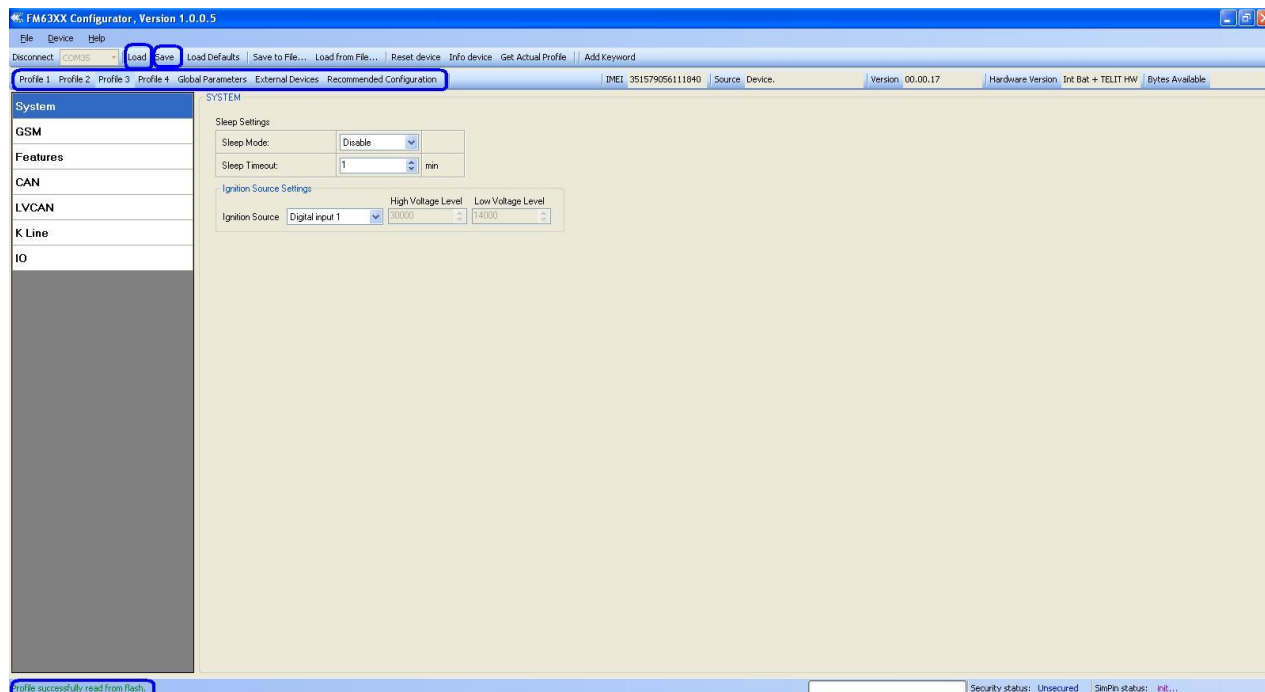

Figure 12 FM6320 Configurator profiles loading window

After changing profile, Global parameters and External Devices, changes can be saved to FM6320 Flash. By pressing “Save” button all 4 profiles, Global parameters and External Devices are saved to the Flash (Figure 13).

Profile successfully read from flash. Security status: Unsecured SimPin status: working, no pin required

Figure 13 FM6320 Configurator profiles saving information

6.3 Parameters Configuration

Global parameters Settings

Global parameters do not depend on selected profile; they are common for all profiles. To configure these parameters choose the TAB named “Global Parameters” and make all necessary changes (Figure 14)

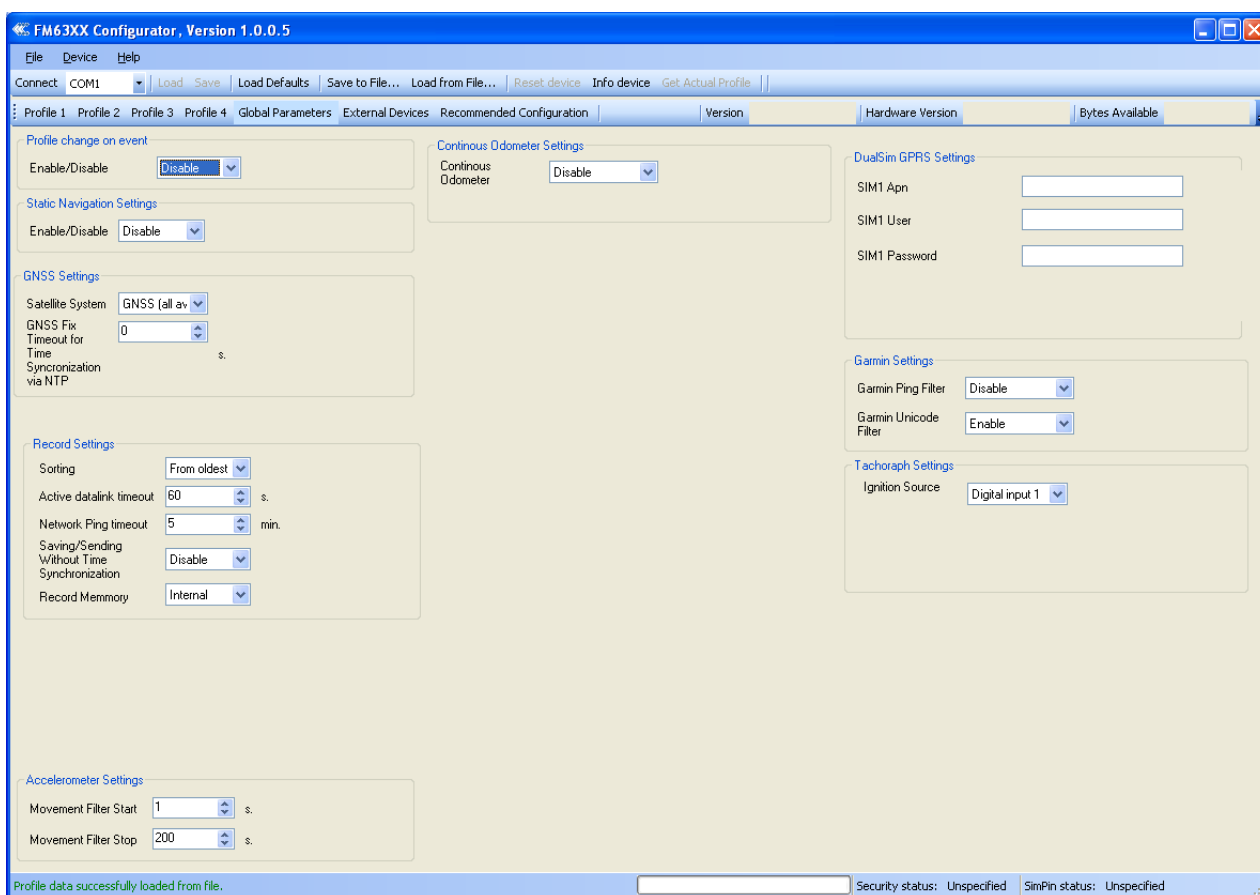

Figure 14 FM6320 Global parameters

Table 8 Global parameters description

Parameter Name	Parameter description
Profile change on event	Allows selecting profile switching method. When 'Profile change on event' is disabled – FM6320 switches profiles depending on GSM operator code method. Otherwise it switches profiles depending on I/O events (see details in chapter 7.2).
Record Settings	Are used to switch between two data sending modes: starting from newest records or starting from oldest record. Active data link timeout defines how many seconds should FM6320 keep connection to the

Parameter Name	Parameter description
	server before disconnecting after successful data transfer. Note that even if it disconnects from server, it always keep active GPRS session.
Accelerometer settings	Defines accelerometer how many seconds should movement be detected by accelerometer in order to set movement for FM6320 application and how many seconds after movement is not detected by accelerometer FM6320 application should treat like movement is still there.
Static Navigation settings	Allows enabling or disabling functionality.
GNSS Settings	Allows choosing compatibility mode and satellite System.
Continuous Odometer settings	Allows enabling or disabling functionality and start value setting.
Garmin settings	Allows enabling or disabling functionality and Unicode.
DualSim GPRS Settings	Allows to enter Sim Apn, user name and password.
Tachograph settings	Allows to choose ignition source for tachograph.

External Devices Settings

External Devices do not depend on selected profile; they are common for all profiles. To configure these parameters choose the TAB named “External Devices” and make all necessary changes (Figure 14)

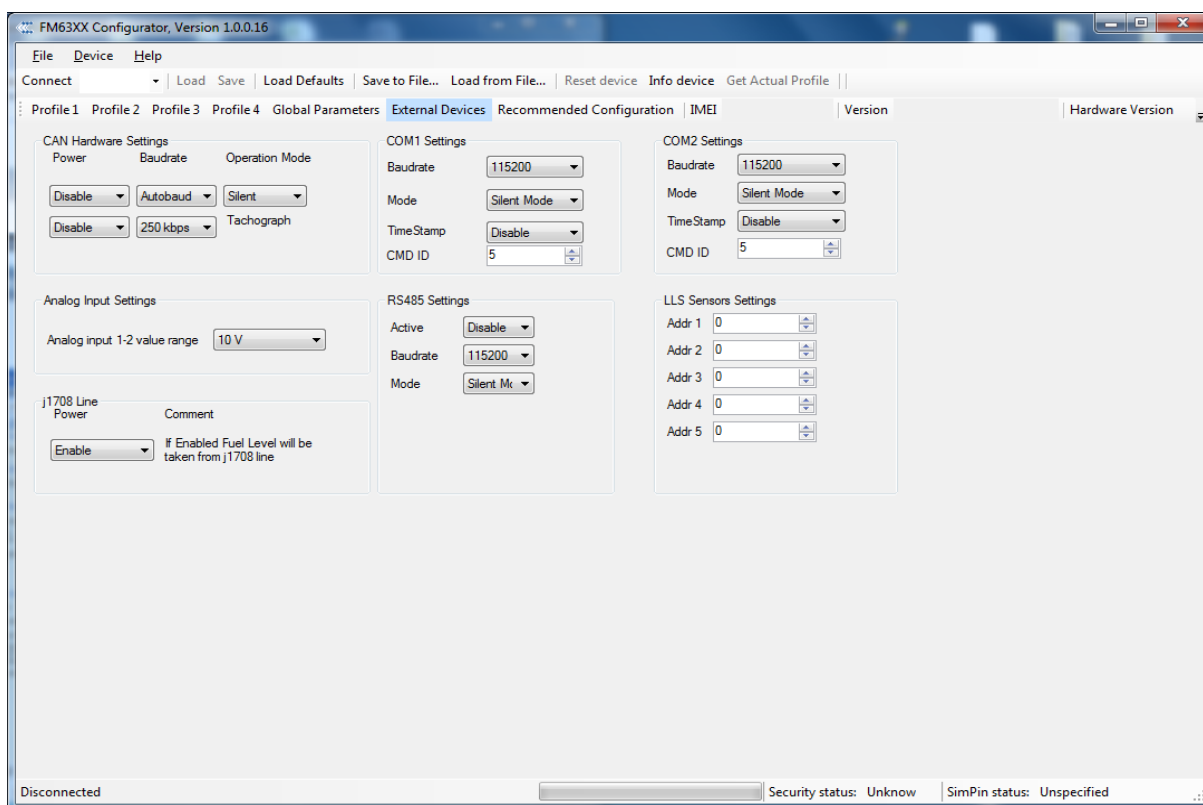

Figure 15 FM6320 Global parameters

Table 9 Global parameters description

Parameter Name	Parameter description
CAN Hardware Settings	Are used to configure CAN line and Tachograph setting such as Enable/Disable, baudrate and operation mode.
Analog Input Settings	User can change the range of analog inputs. There are two possible changes: 10 V (0-10 V) and 30 V (0-30 V).
COM1 and COM2 Settings	Configures COM1 and COM2 ports. User can configure baudrate, working mode, enable/disable timestamp and change CMD ID(used to identify from which COM port data came).
RS485 Settings (COM1)	Configures RS485 settings such as activation of RS485 protocol, baudrate and working mode.
LLS Sensor Settings	Allows user to set LLS sensors addresses in preferred order

Settings and configurable parameters menu

Every FM6320 profile has four main groups of parameters:

1. System – main parameters for all device;
2. GSM has 7 subgroups
 - a. GPRS
 - b. GPRS Limits
 - c. SMS Security
 - d. SMS Data
 - e. SMS Events Numbers
 - f. SMS Events
 - g. Operator list
3. Features has 6 subgroups
 - a. sMode
 - b. Scenarios
 - c. Trip
 - d. Geofencing
 - e. Auto Geofencing
 - f. IButton List
4. CAN
5. LVCAN
6. I/O

6.3.1.1 System Settings

System settings have 2 configurable parameters (Figure 16):

- Sleep settings, where user can disable sleep, turn on or deep sleep.
- Ignition source settings, for choosing which ignition source prefer to use DIN1, DIN2, DIN3, DIN4, Movement or External Voltage. While using External Voltage levels must be set.

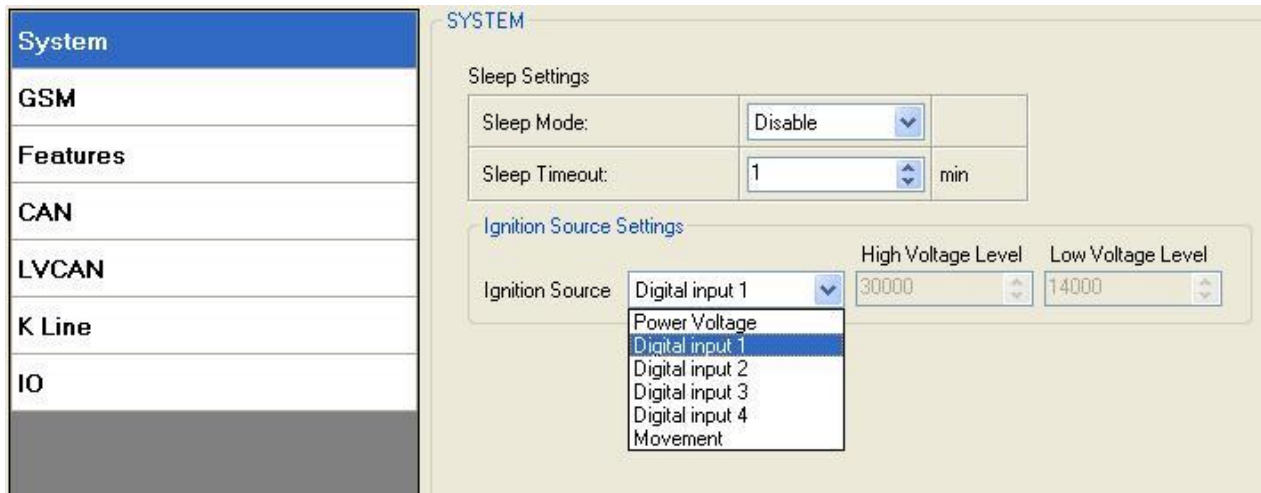

Figure 16 System Settings Configuration

When Vehicle Generator is working supply voltage is usually 2V – 4V volts higher than when it is not. While generator is working, it is too late block engine. Ignition is 1, when power voltage is within high and low levels

Example:

High Level: 15000
 Low Level: 13000

If External Voltage 14V, then ignition is ON.
 If External Voltage 12V, then ignition is OFF.
 If External Voltage 16V, then ignition is OFF.

6.3.1.2 GSM Settings

6.3.1.2.1 GPRS

‘GPRS’ defines main parameters for FM6320: destination server Domain (can be entered either IP or domain name) and port. Also both TCP and UDP protocols are supported. Server Response Time defines the time how long device will wait for response from server before device denies the connection between FM6320 and server.

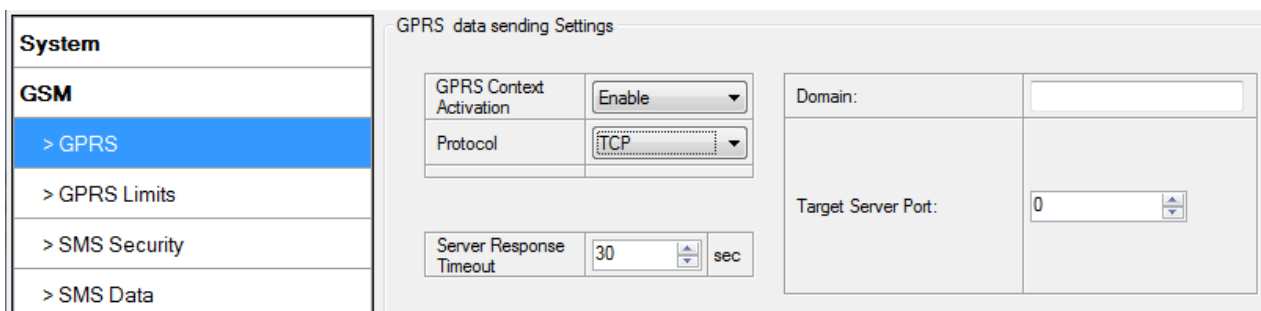

Figure 17 GSM->GPRS Settings Configuration

6.3.1.2.2 Data limits functionality

Data limit can be configured for Home and Roaming Separately. Currently Min Settings for Home and Roaming are 1MB. User can choose to get SMS notification (in SMS Events section) if Data limit has been reached. SMS is send only one time.

User can get current status of datalimits using SMS: **'getlimits'**.

User can reset data limits using SMS: **'resetlimits'**.

These SMS can be GPRS commands too. When data limit will be hit following scenario will be executed:

In TCP mode:

Open GPRS only if there is high or panic Priority. Send only high or panic priority. Low priority records sending will recover on month 1 day.

In UDP mode:

Open GPRS only if there is high or panic Priority. Send only high or panic priority. Low priority records sending will recover on month 1 day.

6.3.1.2.3 SMS Security

Essential fields in 'SMS Security' part is 'SMS Login' and 'SMS Password' (Figure 18). This login and password is used with every SMS sent to FM6320. If login and password are not set, every SMS sent to FM6320 device has to include two spaces before command (<space><space><command>).

Command structure: <login><space><password><space><command>.

Examples:

1. SMS login and password are set - "asd 123 getgps"
2. SMS login and password are not set - " getgps"



Phone numbers have to be written in international standard, without using "+" or "00" signs in prefix. **If no numbers are entered in configuration then commands SMS are allowed to be sent from all GSM numbers.**

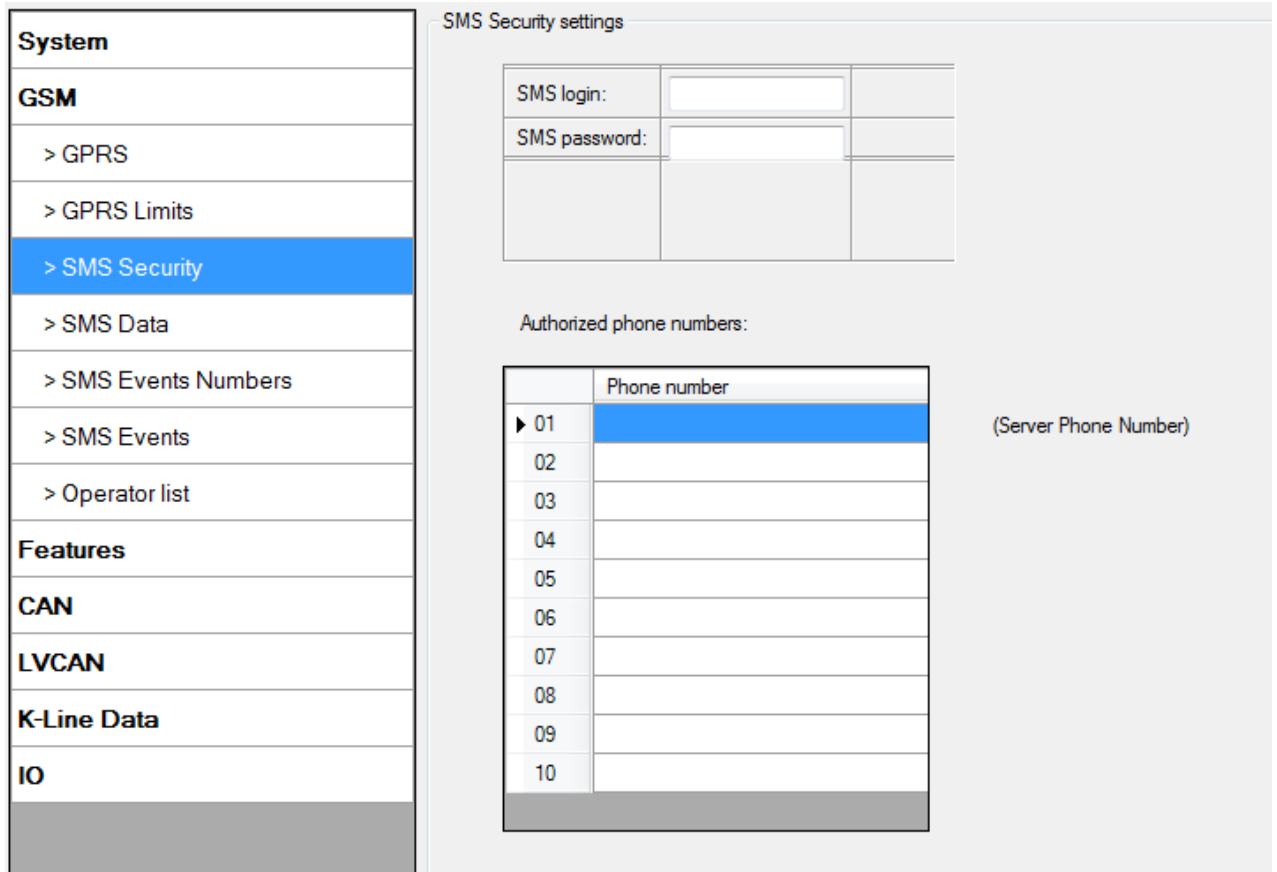

Figure 18 GSM->SMS Settings Configuration (1)

SMS data sending Settings enables or disables **periodic** data and event SMS sending to server (Figure 19). Configuration is divided into 4 main parts:

1. SMS data sending settings;
2. SMS Week Time button;
3. Server Phone Number (has to be written in first position of Authorized phone numbers);
4. SMS Events PreDefined Numbers (phone numbers, to which SMS [has to be written in SMS Event Numbers section] events will be sent);

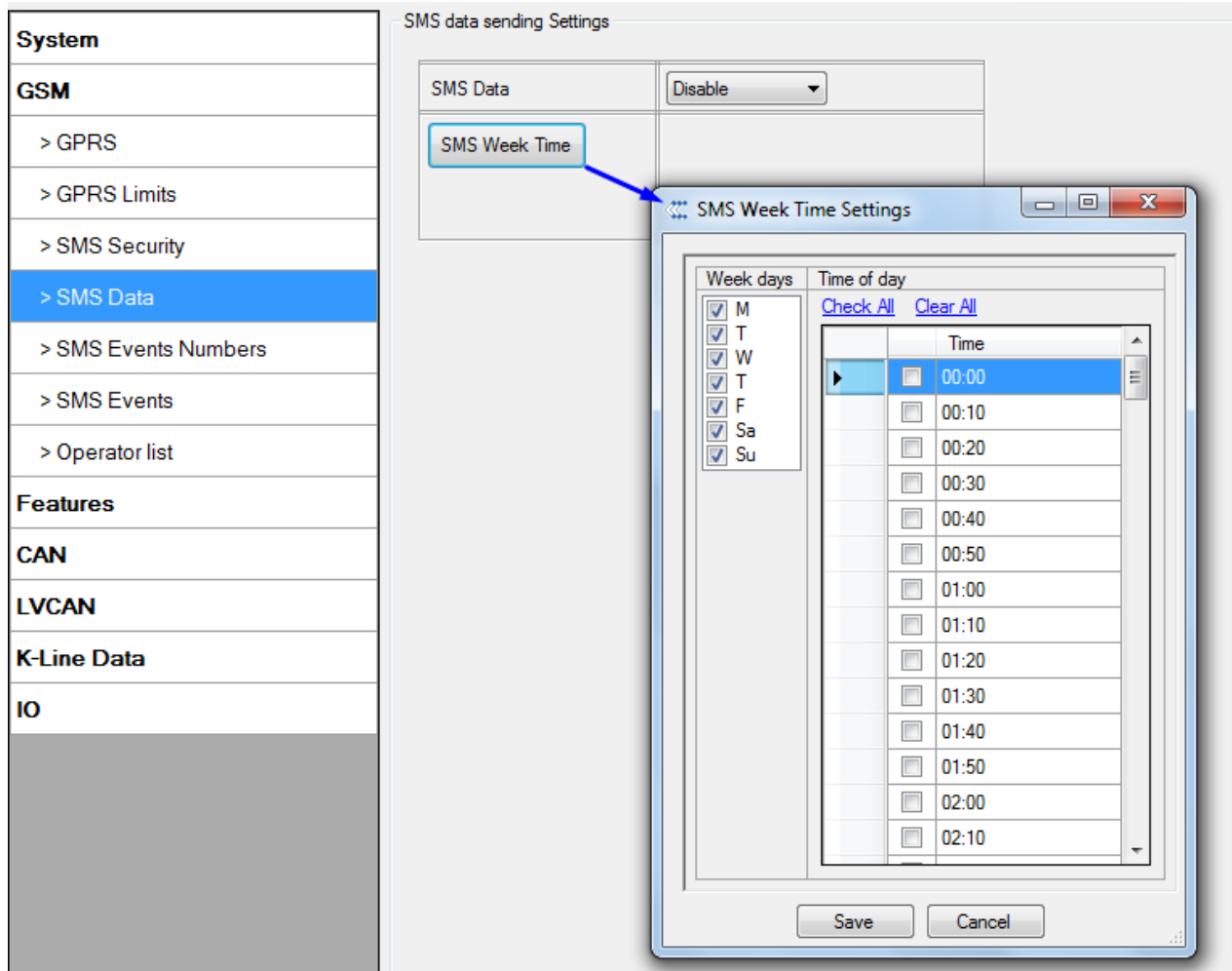

Figure 19 GSM->SMS Settings Configuration (2)

Using these settings FM6320 can send SMS with 24-coordinates in one SMS; it is used in areas where no GPRS coverage is available. Module collects data and sends to server binary SMS containing information about last 24 collected points. SMS sending schedule is set in SMS Week Time tab. 24-Coordinates SMS decoding is described in device documentation document. Please contact Teltonika sale manager to find out more about protocols documentation purchase.

6.3.1.2.4 Operator List

FM6320 is able to use GPRS with all operators but if at least one operator is entered in the list, FM6320 is allowed to connect to GPRS only while operating in listed operator's network. Also operator list has influence on profile switching (see details in chapter 7.1) if Global parameter "Profile switching on event" is disabled.

Operator List

Preferred Roaming Operator List:

	Code
▶ 01	0
02	0
03	0
04	0

Figure 20 FM63 Operator List Configuration

6.3.1.2.5 SMS Events

FM6320 is able to send SMS messages to selected PreDefined phone numbers if any of selected events are triggered.

System	Description	Enable	SMS Number	SMS Text
GSM	Digital input 1	<input checked="" type="checkbox"/>		Digital Input 1
	Digital input 2	<input type="checkbox"/>		Digital Input 2
	Digital input 3	<input type="checkbox"/>		Digital Input 3
	Digital input 4	<input type="checkbox"/>		Digital Input 4
	Digital output 1	<input checked="" type="checkbox"/>		Digital Output 1
	Digital output 2	<input checked="" type="checkbox"/>		Digital Output 2
	Digital output 3	<input checked="" type="checkbox"/>		Digital Output 3
	Digital output 4	<input checked="" type="checkbox"/>		Digital Output 4
	Analog input 1	<input type="checkbox"/>		Analog Input 1
	Analog input 2	<input type="checkbox"/>		Analog Input 2
	Profile	<input type="checkbox"/>		Profile
	Battery Voltage	<input type="checkbox"/>		Bat Voltage
	Battery Current	<input type="checkbox"/>		Bat Current
	GNSS PDOP	<input type="checkbox"/>		GPS PDOP
	GNSS HDOP	<input type="checkbox"/>		GPS HDOP
	External voltage	<input type="checkbox"/>		External Voltage
Gnss Status	<input type="checkbox"/>		GNSS status	
Movement sensor	<input type="checkbox"/>		Movement Sensor	
Odometer value	<input type="checkbox"/>		Odometer value	
GSM operator	<input type="checkbox"/>		GSM Operator	
Speed (km/h)	<input type="checkbox"/>		Actual Speed	
iButton ID	<input type="checkbox"/>		iButton	
GSM signal level	<input type="checkbox"/>		GSM Signal	
Deep sleep	<input type="checkbox"/>		Deep Sleep	
PCB Temperature	<input type="checkbox"/>		PCB Temperature	
Dallas temperature 1	<input type="checkbox"/>		Dallas Temp Sensor 1	
Dallas temperature 2	<input type="checkbox"/>		Dallas Temp Sensor 2	
Dallas temperature 3	<input type="checkbox"/>		Dallas Temp Sensor 3	
Dallas Temperature 4	<input type="checkbox"/>		Dallas Temp Sensor 4	
Fuel Counter	<input type="checkbox"/>		Fuel Counter	
Ignition	<input checked="" type="checkbox"/>		Ignition	

Figure 21 FM63 SMS events List Configuration

6.3.1.3 Features

6.3.1.3.1 sMode

FM6320 is able to collect records using four methods at the same time: time, distance, speed and angle based data acquisition (chapter 8). Send and Save Parameters configuration is available in Features->sMode category (6.3.1.7.1):

- Min Period – time period change that initializes record save.
- Min Angle – angle change that initializes record save (only if vehicle is moving).
- Min Distance – distance change that initializes record save (only if vehicle is moving).
- Send period – GPRS data sending to server period. Module makes attempts to send collected data to server every defined period. If it does not have enough records (depends on parameter Min. Saved Records described above), it tries again after defined time interval.
- Min speed – minimal speed the vehicle has to move in order to save record (only if neither Min Angle nor Min Distance was triggered).
- GPRS Context Week Time tab – most GSM billing systems charge number of bytes (kilobytes) transmitted per session. During the session FM6320 makes connection and transmits data to a server. FM6320 tries to control the session as much as possible. Session can last hours, days, weeks or session can be closed after every connection in certain GSM networks – this depends on GSM network provider. GPRS Context Week Time defines session re-establishing schedule if session was closed by network. New GPRS context is opened if 10 minutes are left till time checked in table. Therefore if all boxes are checked, FM6320 is able to open new connection anytime. At scheduled time match FM6320 checks for GPRS session activity. If GPRS session is alive, FM6320 sends data to server according to Send period parameter. If it is not, FM53 checks if it is able to re-establish the session.

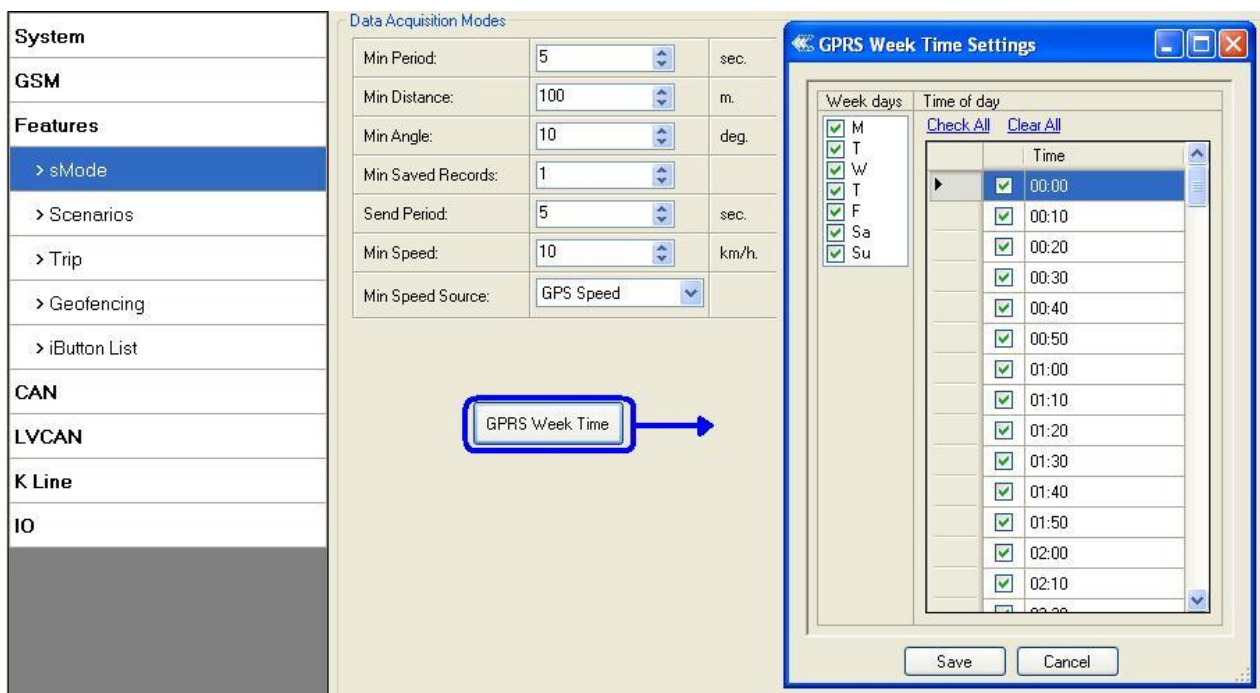

Figure 22 FM53 Operator List Configuration

6.3.1.3.2 Scenarios

In Scenarios window forth different scenarios are available. Three scenarios (Eco/Green Driving, Immobilizer/ Authorizing driving and Over speeding) have six possible states: disabled, no DOUT control, DOUT1 control, DOUT2 control, DOUT3 control, DOUT4 control. Excessive idling scenario have two states: Disable and Enable. All scenarios can be activated at the same time and all scenarios that use DOUT can control the same DOUT. Scenarios configurable parameters are shown in 6.3.1.7.1. All values of these parameters are described in chapter 10.

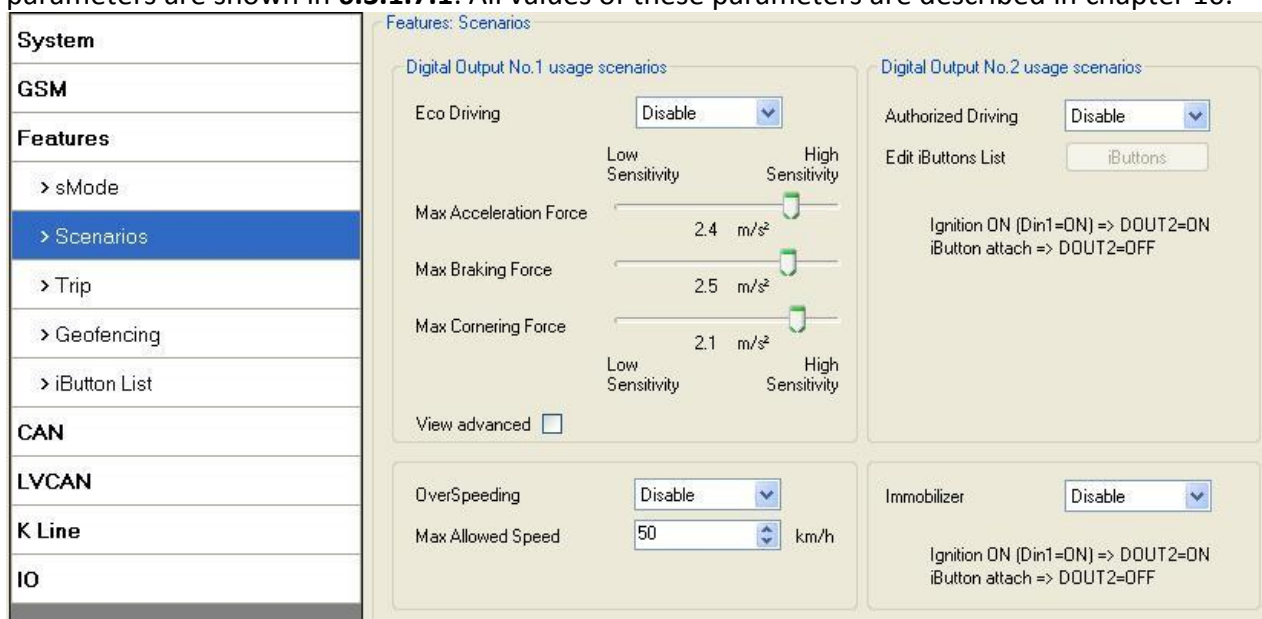

Figure 23 FM53 Operator List Configuration

6.3.1.3.3 Trip

Trip window offers user to configure Trip feature. If Trip is enabled configuration of parameters is available:

- Start Speed – speed, which is detected as minimum speed to indicate Trip start.
- Ignition Off Timeout – timeout to wait if ignition was off, to detect Trip stop.
- Continuous distance counting – Not or Continuous can be chosen in Global parameters (see paragraph “**Global parameters Settings**”). For this feature I/O Odometer must be enabled.

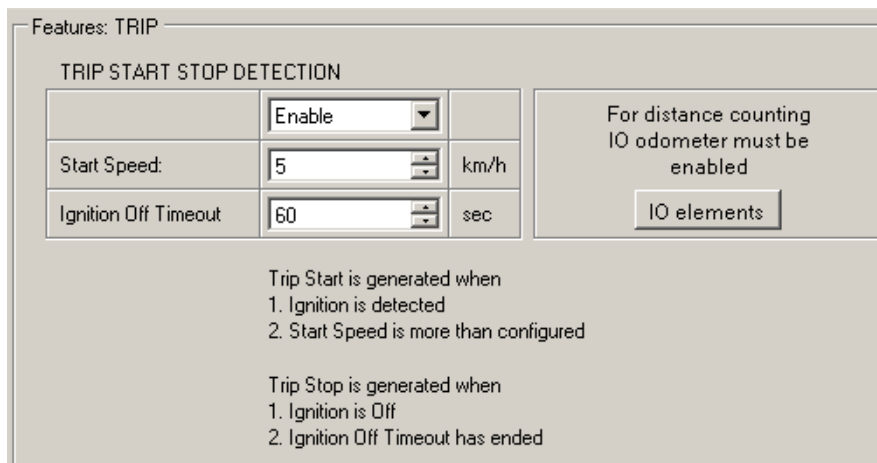

Figure 24 FM53 Features->Trip Configuration

If I/O Odometer is enabled and Continuous distance counting variable is set to Continuous, Trip distance is going to be counted continuously (from Trip start to Trip stop). This value is written to I/O Odometer value field. When Trip is over and next Trip begins, Odometer value is not reset to zero, it is counted continuously again.

If I/O Odometer is enabled and Continuous Distance Counting variable is set to "Not", then distance is going to be counted only between every record made. This value is written to I/O Odometer value field and reset to zero every new record until Trip stops. If later all Odometer values are summed up manually user gets distance driven over the whole Trip period.

6.3.1.3.4 Geofencing

6.3.1.3.4.1 Geofencing settings

FM6320 has 20 configurable Geofence zones and it can generate event when defined Geofence zone border has been crossed.

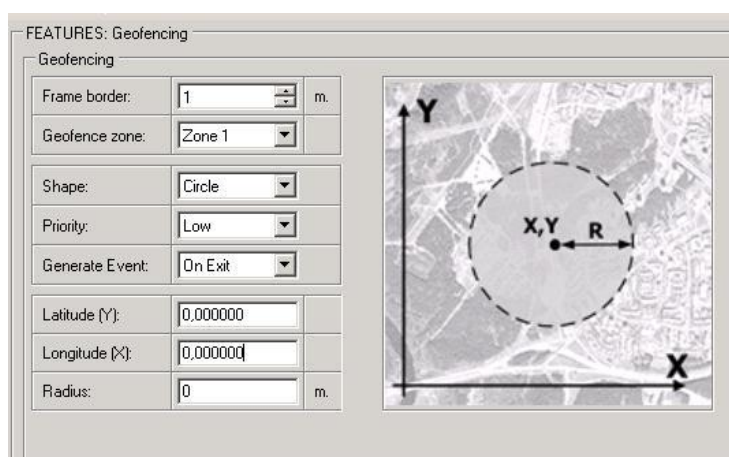

Figure 25 FM53 Features->Geofencing Configuration (1)

Configuration of the parameters is available in Features->Geofencing (Figure 25)

- Frame border – frame border is an additional border around Geofence zone. It is additional area around defined zone used to prevent false event recording when object stops on the border of the area and because of GPS errors some records are made inside area and some – outside. Event is generated only when both borders are crossed. See figure 26 for details: track 1 is considered to enter the area while track 2 does not.

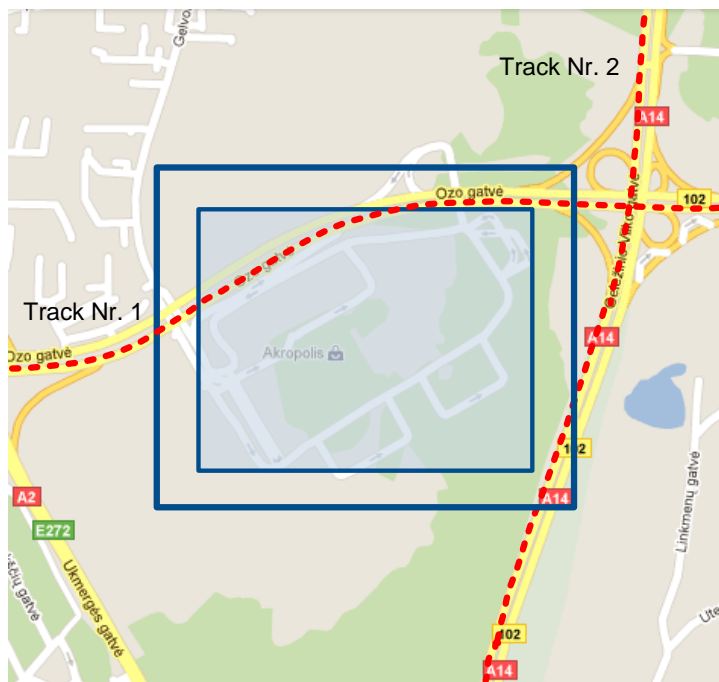

Figure 26 Geofence border

- Shape – can be rectangular or circle
- Priority – priority of Geofence event: low, high or panic, SW21, SW22, SW23, SW24. These levels define priority of event information sending to server. See I/O element description for more details about priorities.
- Generate event (On entrance, On exit, On both) – choose when record will be generated (or no event);
- X1 – geofence zone left bottom corner X coordinate;
- Y1 – geofence zone left bottom corner Y coordinate;
- X2 or R – geofence zone upper right corner X coordinate (radius of circle when Circular zone used);
- Y2 – geofence zone upper right corner Y coordinate;

6.3.1.3.4.2 AutoGeofencing settings

AutoGeofence – the last known position after movement = off. If your car is being taken away – you can be notified. The shape and size of the geofence zones are configurable. There is a possibility to state whether entering in or out of the geofence triggers an asynchronous message.

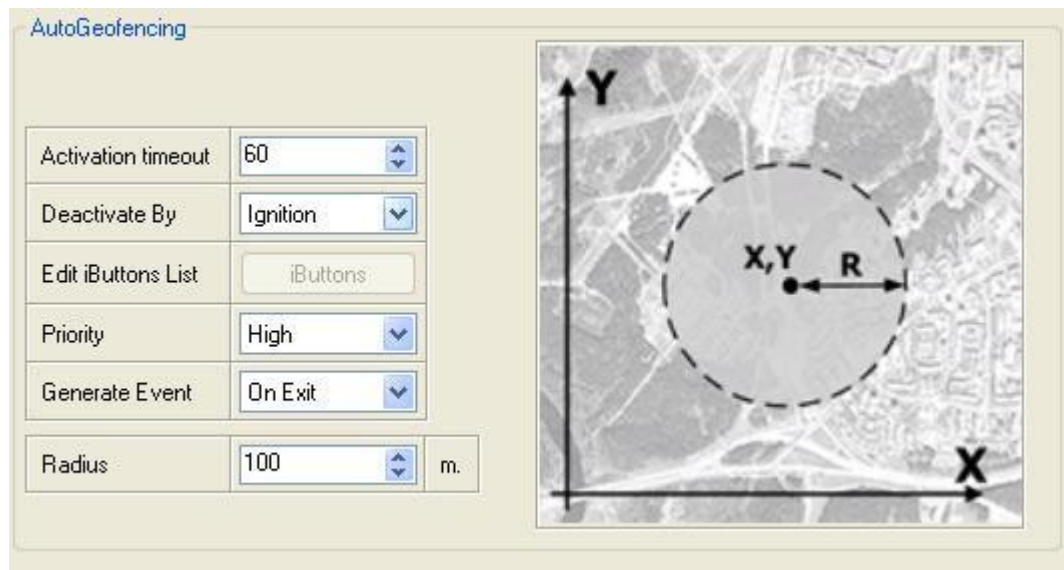

Figure 27 FM53 Features->Geofencing Configuration (2)

Auto Geofencing option can be configured by following parameters (Figure 27):

- Activation TMO – Time period before Geofence is activated after vehicle stops.
- Deactivate By:
 - Ignition – if ignition becomes high it will drop AutoGeofence Zone
 - iButton – if iButton is attached it will drop AutoGeofence Zone
- Edit iButton List – if list is not empty, attached iButton is tested against iButton list, if match is found AutoGeofence zone is dropped.
- Priority – Priority of generated event, which will be applied to saved record.
- Generate Event:
 - Enter Event – Event generation on Geofence entrance.
 - Exit Event – Event generation on Geofence exit.
 - On Both - Event generation on Geofence entrance or exit.
 - No Event

Auto Geofencing does not require entering coordinates, instead it requires GPS visibility. If vehicle stopped and activation timeout is reached, Auto Geofence will be created around the vehicles last position by set Radius value. Auto Geofence event generation works the same as Geofencing mentioned above.

6.3.1.3.5 iButton List

iButton list is used to enter authorized iButton ID codes, which are used to authenticate driver in Authorized driving and Auto Geofencing options.

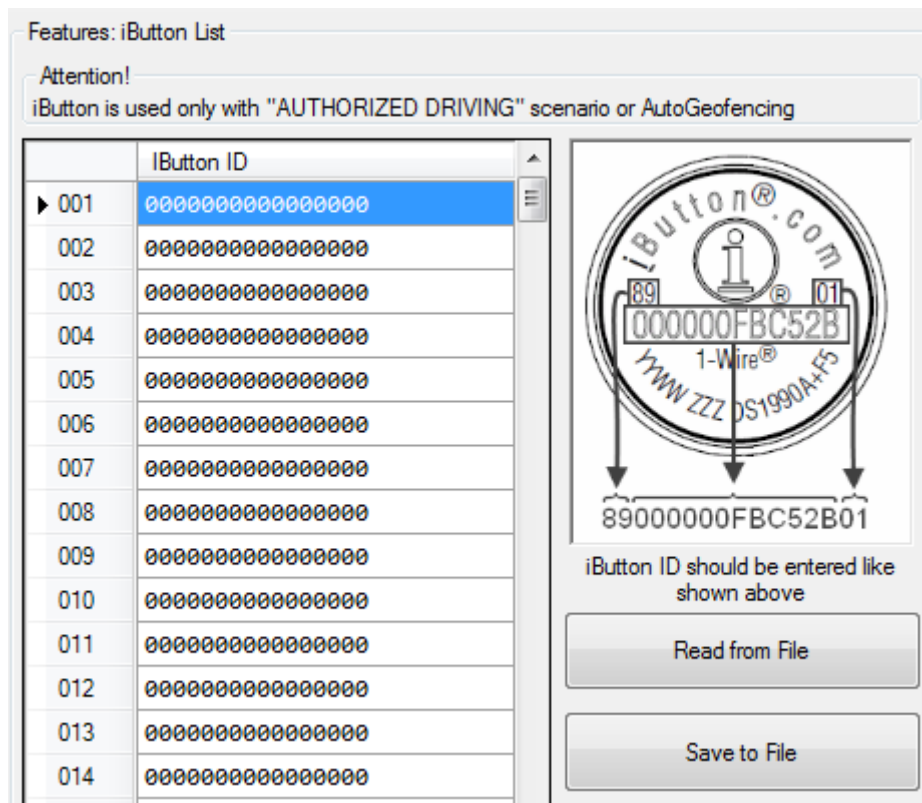

Figure 28 Features->iButton Configuration

iButton value must be entered as it is written on it. User can save 500 iButtons to .csv file and read them from same file using *Read from File* and *Save to File* buttons.

6.3.1.4 CAN

CAN - Controller Area Network (CAN or CAN-bus) is a computer network protocol and bus standard designed to allow microcontrollers and devices to communicate with each other and without a host computer.

6.3.1.4.1 CAN interface parameters

CAN 1 Enable parameter (ID=146)

Parameter enables or disables CAN 1 interface. Possible values: 0 – disable, 1 – enable.

Table 10 CAN 1 Enable parameter

Minimum value	Maximum value	Recommended value	Value type
0	1	1	U8

CAN 1 Baud Rate (ID=147)

Parameter defines CAN 1 bus baud rate. For Auto Baud rate ID=760 value is 0. Available baud rates are 50, 100, 125, 250, 500 and 1000 kbps.

Table 10 CAN 1 Baud Rate

Minimum value	Maximum value	Recommended value	Value type
0	1000	250	U32

CAN 1 operational mode (ID=148)

Parameter defines if CAN 1 line working at silent mode or normal mode. 0 – Silent, 1 – Normal.

Table 11 CAN Baud Rate

Minimum value	Maximum value	Recommended value	Value type
0	1	1	U8

CAN 2 Enable parameter (Used for tachograph) (ID=149)

Parameter enables or disables CAN 2 interface. Possible values: 0 – disable, 1 – enable.

Table 12 CAN 2 Enable parameter

Minimum value	Maximum value	Recommended value	Value type
0	1	1	U8

CAN 2 Baud Rate (ID=150)

Parameter defines CAN 2 bus baud rate. Available baud rates are 250, 500.

Table 13 CAN Baud Rate

Minimum value	Maximum value	Recommended value	Value type
250	500	250	U32

CAN#0 I/O (ID=x406)

CAN#0 I/O parameter priority

Parameter defines CAN I/O element priority level. There are three possible priorities: 0 – Low, 1 – High, 2 – Panic.

Table 14 CAN#0 I/O priority

Minimum value	Maximum value	Recommended value	Goes with (depends on) parameters	Value type
0	2	0	CAN#0 I/O HighLevel CAN#0 I/O LowLevel CAN#0 I/O Logic Operand CAN#0 I/O Averaging Constant CAN#0 I/O CAN Type ID CAN#0 I/O OutputDataMask CAN#0 I/O CAN ID	U8

CAN#0 I/O HighLevel

Parameter defines high value of triggered I/O property. This parameter is used to set thresholds for CAN I/O properties to generate events.

Table 15 CAN#0 I/O HighLevel

Minimum value	Maximum value	Recommended value	Goes with (depends on) parameters	Value type
0	9999999	1	CAN#0 I/O Priority CAN#0 I/O LowLevel CAN#0 I/O Logic Operand CAN#0 I/O Averaging Constant CAN#0 I/O CAN Type ID CAN#0 I/O OutputDataMask CAN#0 I/O CAN ID	S32

CAN#0 I/O LowLevel

Parameter defines low value of triggered I/O property. This parameter is used to set thresholds for CAN I/O properties to generate events.

Table 16 CAN#0 I/O LowLevel

Minimum value	Maximum value	Recommended value	Goes with (depends on) parameters	Value type
0	9999999	0	CAN#0 I/O Priority CAN#0 I/O HighLevel CAN#0 I/O Logic Operand CAN#0 I/O Averaging Constant CAN#0 I/O CAN Type ID CAN#0 I/O OutputDataMask CAN#0 I/O CAN ID	S32

CAN#0 I/O Logic Operand

Parameter defines when event is sent: 0 is event on exit, 1 – on entrance, 2 – on both, 3 – monitoring, 4 – hysteresis, 5 – on change.

Table 17 CAN#0 I/O Logic Operand

Minimum value	Maximum value	Recommended value	Goes with (depends on) parameters	Value type
0	5	0	CAN#0 I/O Priority CAN#0 I/O HighLevel CAN#0 I/O LowLevel CAN#0 I/O Averaging Constant CAN#0 I/O CAN Type ID CAN#0 I/O OutputDataMask CAN#0 I/O CAN ID	U8

CAN#0 I/O Averaging Constant

Parameter defines I/O property sample length to average. If no averaging needed default value is 1.

Table 18 CAN#0 I/O Averaging Constant

Minimum value	Maximum value	Recommended value	Goes with (depends on) parameters	Value type
1	99999999	1	CAN#0 I/O Priority CAN#0 I/O HighLevel CAN#0 I/O LowLevel CAN#0 I/O Logic Operand CAN#0 I/O CAN Type ID CAN#0 I/O OutputDataMask CAN#0 I/O CAN ID	S32

CAN#0 I/O CAN Type ID

Parameter defines CAN element ID length. CAN element ID could be 11 or 29 bits length. For 11 bits ID parameter value is 0, for 29 bits ID – 1.

Table 11 CAN#0 CAN Type ID

Minimum value	Maximum value	Recommended value	Goes with (depends on) parameters	Value type
0	1	1	CAN#0 I/O Priority CAN#0 I/O HighLevel CAN#0 I/O LowLevel CAN#0 I/O Logic Operand CAN#0 I/O Averaging Constant CAN#0 I/O OutputDataMask CAN#0 I/O CAN ID	U8

CAN#0 Output data mask

Parameter defines CAN data mask. This parameter is 8 bit length and indicates which data bytes of CAN message are sent for calculation and which are ignored. Bit value 1 means that CAN data byte will be preceded and sent to server.

Example: 00110011 is 51 integer.

Table 12 CAN#0 Output data mask

Minimum value	Maximum value	Recommended value	Goes with (depends on) parameters	Value type
0	FF	-	CAN#0 I/O Priority CAN#0 I/O HighLevel CAN#0 I/O LowLevel CAN#0 I/O Logic Operand CAN#0 I/O Averaging Constant CAN#0 I/O CAN Type ID CAN#0 I/O CAN ID	U8

CAN#0 CAN ID

Parameter defines CAN identifier. ID can be 11 or 29 bits length.

Example: 18FEE925 (total fuel used)

Table 21 CAN#0 CAN ID

Minimum value	Maximum value	Recommended value	Goes with (depends on) parameters	Value type
0	FFFFFFFF	-	CAN#0 I/O Priority CAN#0 I/O HighLevel CAN#0 I/O LowLevel CAN#0 I/O Logic Operand CAN#0 I/O Averaging Constant CAN#0 I/O CAN Type ID CAN#0 I/O OutputDataMask	U32

To configure CAN#0 I/O element every value above should be separated with comma. For example, configuring first profile CAN# I/O element by SMS, SMS should look like: " setparam 1406 1,0,0,1,1,00110011,18FEE925" (" setparam 1406 <priority>,<HighLevel>,<LowLevel>,<LogicOperand>,<AveragingConstant>,<CANTypeID>,<outputDataMask>,<CANID>")

The rest CAN elements are configured in the same sequence. CAN elements and parameters ID's are listed below.

Table 22 CAN elements and parameters

CAN Element Number	CAN Element parameters
CAN#0	x406
CAN#1	x407
CAN#2	x408
CAN#3	x409
CAN#4	x410
CAN#5	x411
CAN#6	x412
CAN#7	x413
CAN#8	x414
CAN#9	x415



There are only 14 I/O parameters that could use Averaging Constant: Digital Inputs (1-4); Analog Inputs (1-4); Battery Voltage; Battery Current; External Voltage; PDOP; HDOP; Speedometer.

I/O parameters: "Current Profile", "Fuel level meter" (1-2), "Fuel temperature" (1-2), "GNSS Status", "Movement", "Active GSM Operator", "iButton ID", "Odometer", "GSM Signal", "Deep Sleep", "Cell ID", "Area Code", "PCB Temperature", "Dallas temperature Sensor 0.2", "Fuel Counter" and "RFID ID" cannot use Averaging constant functionality.

6.3.1.5 I/O

If all I/O elements are disabled AVL packet comes with GPS information only. After enabling I/O element(s) AVL packet in couple with GPS information contains current value(s) of enabled I/O element.

6.3.1.5.1 FM6320 available I/O list

Table 23 PERMANENT I/O elements list description

Permanent I/O elements (are always sent (with every record) to server if enabled)			
Nr.	Property Name	Bytes	Description
1	Digital Input Status 1	1	Logic: 0 / 1
2	Digital Input Status 2	1	Logic: 0 / 1
3	Digital Input Status 3	1	Logic: 0 / 1
4	Digital Input Status 4	1	Logic: 0 / 1
5	Digital Output Status 1	1	Logic: 0 / 1
6	Digital Output Status 2	1	Logic: 0 / 1
7	Digital Output Status 3	1	Logic: 0 / 1
8	Digital Output Status 4	1	Logic: 0 / 1
9	Analog Input 1	3	Voltage: mV, 0 – 30 V
10	Analog Input 2	3	Voltage: mV, 0 – 30 V
11	Profile	1	Value in scale 1 – 4
12	Battery Voltage	2	Voltage: mV
13	Battery Current	2	Voltage: mA
14	GNSS PDOP	2	Probability * 10; 0-500
15	GNSS HDOP	2	Probability * 10; 0-500
16	External Voltage	2	Voltage: mV, 0 – 30 V
17	GNSS status	2	0-off/ 1-no antenna (only when using NAVYS)/ 2- no fix/ 3-got fix/ 4-sleep/ 5-over current
18	Movement sensor	1	0 – not moving, 1 – moving.
19	Odometer value	4	Distance between two records: m
20	GSM Operator	4	Currently used GSM Operator code
21	Speed	2	Value in km/h, 0 – xxx km/h
22	iButton ID	8	iButton ID number
23	GSM signal level	2	Value in scale 1 – 5
24	Deep Sleep	1	0 – not deep sleep mode, 1 – deep sleep mode
25	PCB Temperature	2	10 * Degrees (°C)
26	Dallas ID 1	9	Shows ID of first Dallas sensor
27	Dallas Temperature 1	8	10 * Degrees (°C), -55 - +115, if 3000 – Dallas error
28	Dallas ID 2	9	Shows ID of second Dallas sensor
29	Dallas Temperature 2	8	10 * Degrees (°C), -55 - +115, if 3000 – Dallas error
30	Dallas ID 3	9	Shows ID of third Dallas sensor
31	Dallas Temperature 3	8	10 * Degrees (°C), -55 - +115, if 3000 – Dallas error
32	Dallas ID 3	9	Shows ID of fourth Dallas sensor
33	Dallas Temperature 4	8	10 * Degrees (°C), -55 - +115, if 3000 – Dallas error
34	Fuel Counter	4	Difference of generated impulses on two signal lines
35	Ignition	1	0 – ignition is off, 1 – ignition is on
36	RFID	9	Displays activated RFID card ID
37	LLS #1Fuel	3	Fuel level, measured by LLS sensor on COM2, in kvants

Permanent I/O elements (are always sent (with every record) to server if enabled)			
Nr.	Property Name	Bytes	Description
			or liters.
38	LLS #1 temperature	2	Fuel temperature, measured by LLS sensor on COM2, in degrees Celsius.
39	LLS #2 Fuel	3	Fuel level, measured by LLS sensor on COM2, in kvants or liters.
40	LLS #2 temperature	2	Fuel temperature, measured by LLS sensor on COM2, in degrees Celsius.
41	LLS #3 Fuel	3	Fuel level, measured by LLS sensor on COM2, in kvants or liters.
42	LLS #3 temperature	2	Fuel temperature, measured by LLS sensor on COM2, in degrees Celsius.
43	LLS #4 Fuel	3	Fuel level, measured by LLS sensor on COM2, in kvants or liters.
44	LLS #4 temperature	2	Fuel temperature, measured by LLS sensor on COM2, in degrees Celsius.
45	LLS #5 Fuel	3	Fuel level, measured by LLS sensor on COM2, in kvants or liters.
46	LLS #5 temperature	2	Fuel temperature, measured by LLS sensor on COM2, in degrees Celsius.

Table 24 EVENTUAL I/O elements list description

Eventual IO elements (generated and sent record to server only if appropriate conditions are met)			
Nr.	Property Name	Bytes	Description
43	CAN 0	Varying ⁴	ID Specific data
44	CAN 1	Varying	ID Specific data
45	CAN 2	Varying	ID Specific data
46	CAN 3	Varying	ID Specific data
47	CAN 4	Varying	ID Specific data
48	CAN 5	Varying	ID Specific data
49	CAN 6	Varying	ID Specific data
50	CAN 7	Varying	ID Specific data
51	CAN 8	Varying	ID Specific data
52	CAN 9	Varying	ID Specific data
53	Geofence zone 01	1	Event: 0 – target left zone, 1 – target entered zone
54	Geofence zone 02	1	Event: 0 – target left zone, 1 – target entered zone
55	Geofence zone 03	1	Event: 0 – target left zone, 1 – target entered zone
56	Geofence zone 04	1	Event: 0 – target left zone, 1 – target entered zone
57	Geofence zone 05	1	Event: 0 – target left zone, 1 – target entered zone
58	Geofence zone 06	1	Event: 0 – target left zone, 1 – target entered zone
59	Geofence zone 07	1	Event: 0 – target left zone, 1 – target entered zone
60	Geofence zone 08	1	Event: 0 – target left zone, 1 – target entered zone
61	Geofence zone 09	1	Event: 0 – target left zone, 1 – target entered zone

⁴ CAN property length can vary depending on filter settings. Data can be sent as 1, 2, 4 or 8 byte property.

Eventual IO elements (generated and sent record to server only if appropriate conditions are met)			
Nr.	Property Name	Bytes	Description
62	Geofence zone 10	1	Event: 0 – target left zone, 1 – target entered zone
63	Geofence zone 11	1	Event: 0 – target left zone, 1 – target entered zone
64	Geofence zone 12	1	Event: 0 – target left zone, 1 – target entered zone
65	Geofence zone 13	1	Event: 0 – target left zone, 1 – target entered zone
66	Geofence zone 14	1	Event: 0 – target left zone, 1 – target entered zone
67	Geofence zone 15	1	Event: 0 – target left zone, 1 – target entered zone
68	Geofence zone 16	1	Event: 0 – target left zone, 1 – target entered zone
69	Geofence zone 17	1	Event: 0 – target left zone, 1 – target entered zone
70	Geofence zone 18	1	Event: 0 – target left zone, 1 – target entered zone
71	Geofence zone 19	1	Event: 0 – target left zone, 1 – target entered zone
72	Geofence zone 20	1	Event: 0 – target left zone, 1 – target entered zone
73	Auto Geofence	1	Event: 0 – target left zone, 1 – target entered zone
74	Trip	1	1 – trip start, 0 – trip stop
75	Immobilizer	1	1 – iButton connected
76	Authorized driving	1	1 – authorized iButton connected
77	ECO driving/Green driving type	1	1 – harsh acceleration, 2 – harsh braking, 3 - harsh cornering
78	ECO driving/Green driving value	1	Depending on ECO driving/Green driving type: if harsh acceleration, braking and cornering – $g \cdot 10 \text{ m/s}^2$
79	Over Speeding	1	At over speeding start km/h, at over speeding end km/h
80	Excessive idling	1	1- idling detected, 0- idling ended



There are two types of operations with Permanent I/O elements: simple monitoring and event generating. Monitoring method is used when current I/O information needed with regular GPS coordinates. Event generating method is used when additional AVL packet is needed when current value of I/O exceeds predefined High and Low levels. I/O settings allow defining I/O event criteria.

6.3.1.5.2 I/O configuring

I/O configuration has 7 main parts (Figure 29):

System	I/O						
	Property Input	<input type="checkbox"/> Enabled	Priority	LowLevel	HighLevel	GenerateEvent	Averaging Constant
GSM	Digital input 1	<input type="checkbox"/>	Disable	0	0	On Both	10
Features	Digital input 2	<input type="checkbox"/>	Disable	0	0	Monitoring	10
CAN	Digital input 3	<input type="checkbox"/>	Disable	0	0	Monitoring	10
LVCAN	Digital input 4	<input type="checkbox"/>	Disable	0	0	Monitoring	10
K-Line Data	Digital output 1	<input type="checkbox"/>	Disable	0	0	Monitoring	10
IO	Digital output 2	<input type="checkbox"/>	Disable	0	0	Monitoring	10
	Digital output 3	<input type="checkbox"/>	Disable	0	0	Monitoring	10
	Digital output 4	<input type="checkbox"/>	Disable	0	0	Monitoring	10
	Analog input 1	<input type="checkbox"/>	Disable	0	0	Monitoring	10
	Analog input 2	<input type="checkbox"/>	Disable	0	0	Monitoring	10
	Profile	<input type="checkbox"/>	Disable	0	0	Monitoring	10
	Battery Voltage	<input type="checkbox"/>	Disable	0	0	Monitoring	10
	Battery Current	<input type="checkbox"/>	Disable	0	0	Monitoring	10
	GNSS PDOP	<input type="checkbox"/>	Disable	0	0	Monitoring	10
	GNSS HDOP	<input type="checkbox"/>	Disable	0	0	Monitoring	10
	External voltage	<input type="checkbox"/>	Disable	11000	30000	Monitoring	10
	Gnss Status	<input type="checkbox"/>	Disable	0	0	Monitoring	10
	Movement sensor	<input type="checkbox"/>	Disable	0	0	On Exit	10
	Odometer value	<input type="checkbox"/>	Disable	0	0	Monitoring	10
	GSM operator	<input type="checkbox"/>	Disable	0	0	Monitoring	10
	Speed (km/h)	<input type="checkbox"/>	Disable	0	0	Monitoring	10
	iButton ID	<input type="checkbox"/>	Disable	0	0	Monitoring	10
	GSM signal level	<input type="checkbox"/>	Disable	0	0	Monitoring	10
	Deep sleep	<input type="checkbox"/>	Disable	0	0	Monitoring	10
	PCB Temperature	<input type="checkbox"/>	Disable	0	0	Monitoring	10

Figure 29 FM53 I/O Configuration (1)

Table 25 I/O Configuration window description

Pos. Nr.	DESCRIPTION
1.	Property inputs list
2.	Enable/Disable chosen property input - allows enabling I/O element so it is added to the data packet and is sent to the server. By default, all I/O elements are disabled and FM6320 records only GPS information.
3.	Priority - AVL packet priority. There are Low, High, Panic, SW21, SW22, SW23 and SW24 priorities. Regular packets are sent as Low priority records. When low priority event is triggered, FM6320 makes additional record with indication that the reason for that was I/O element change. When High priority is selected, module makes additional record with high priority flag and sends event packet immediately to the server. First it tries to send it using GPRS. If GPRS fails, it doesn't send AVL packet using SMS mode, if SMS is enabled in SMS settings. Panic priority event forces module to send AVL packet to server via GPRS and if GPRS fails, it sends AVL packet using SMS mode, if SMS is enabled in SMS settings. Then it switches its operating profile to Profile 4 (for details see chapter 7.2). SW2X priorities switch profiles on event (SW21 – Profile 1, SW22 – Profile 2 and so on).
4.	High Level - define I/O value range. If I/O value enters or exits this range, FM6320 generates event.
5.	Low Level – define I/O value range. If I/O value enters or exits this range, FM6320 generates event.

Pos. Nr.	DESCRIPTION
6.	Generate event – defines when to generate event. When value enters defined range, exits it or both enters and exits.
7.	<p>Averaging Constant – it is an I/O event delay parameter. In some applications there is no need to generate events on every I/O range enter/exit immediately. Sometimes it is necessary to wait some time interval before event generating to be ensuring that current event is not a short time event. Averaging constant allows setting I/O event delay (averaging). If I/O value is entering or leaving predefined range, it must have same value for Averaging constant time. One unit of averaging constant value equals 20 milliseconds.</p> <p>Selected data source value input averaging constant are calculated by following formula:</p> $VAL^{Mean} = \frac{VAL^{Mean-1} \times (CONST - 1) + REALVAL}{CONST}$ <p>Where: VAL^{Mean} – Value calculated during actual cycle⁵; VAL^{Mean-1} – Value calculated during previous cycle; CONST – Averaging constant; REALVAL – Real value detected on digital input.</p>

6.3.1.5.3 I/O properties

I/O properties are additional data sources, which are recorded along with usual GPS data.

IO#0 (ID=x300)

I/O#0 priority

Parameter defines I/O property type of priority: 0 is disabled, 1 is low, 2 – high, 3 – panic, 4 – SW21, 5 – SW22, 6 – SW23, 7 – SW24.

Table 26 I/O Type of Priority

Minimum value	Maximum value	Recommended value	Goes with (depends on) parameters	Value type
0	7 (ex. 3)	0	I/O#0 property parameter I/O#0 High level I/O#0 Low level I/O#0 logic operand I/O#0 averaging constant	S8

⁵ One cycle equal to 20 ms.

I/O#0 High level

Parameter defines high value of triggered I/O property. This parameter is used to set thresholds for I/O properties to generate events.

Table 27 I/O High Value

Minimum value	Maximum value	Recommended value	Goes with (depends on) parameters	Value type
0	9999999	1	I/O#0 property parameter - priority I/O#0 Low level I/O#0 logic operand I/O#0 averaging constant	S32

I/O#0 Low level

Parameter defines low value of triggered I/O property. This parameter is used to set thresholds for I/O properties to generate events.

Table 28 I/O Low Value

Minimum value	Maximum value	Recommended value	Goes with (depends on) parameters	Value type
0	9999999	0	I/O#0 property parameter - priority I/O#0 High level I/O#0 logic operand I/O#0 averaging constant	S32

I/O#0 logic operand

Parameter defines when event is sent: 0 is event on exit, 1 – on entrance, 2 – on both, 3 – monitoring, 4 – hysteresis, 5 – on change.

Table 29 I/O Logic Operand

Minimal value	Maximum value	Recommended value	Goes with (depends on) parameters	Value type
0	5	2	I/O#0 priority	S8

			I/O#0 High level I/O#0 Low level I/O#0 averaging constant IO#0 (ID=x300)	
--	--	--	---	--

I/O#0 averaging constant

Parameter defines I/O property sample length to average. If no averaging needed default value is 1.

Table 30 I/O Averaging constant

Minimum value	Maximum value	Recommended value	Goes with (depends on) parameters	Value type
1	99999999	1	IO#0 (ID=x300) I/O#0 priority I/O#0 High level I/O#0 Low level I/O#0 logic operand	S32

To configure I/O#0 element every value above should be separated with comma. For example, configuring first profile I/O#0 element by SMS, SMS should look like: " setparam 1300 1,0,0,1,1" (" setparam 1300 <priority>,<HighLevel>,<LowLevel>,<Operand>,<Avg Constant>")

Other I/O property elements can be configured in the same logic. All I/O element parameters are listed below.

Table 31 I/O Elements

I/O Element Number	I/O element parameters	I/O Element Number	I/O element parameters
I/O#0 – Digital input 1	x300	I/O#23 – Deep Sleep	x323
I/O#1 – Digital input 2	x301	I/O#24 – PCB Temp.	x324
I/O#2 – Digital input 3	x302	I/O#25 – Dallas ID 1	x325
I/O#3 – Digital input 4	x303	I/O#26 – Dallas Temp. 1	x326
I/O#4 – Digital input 1	x304	I/O#27 – Dallas ID 2	x327

I/O#5 – Digital input 2	x305	I/O#28 – Dallas Temp. 2	x328
I/O#6 – Digital input 3	x306	I/O#29 – Dallas ID 3	x329
I/O#7 – Digital input 4	x307	I/O#30 – Dallas Temp. 3	x330
I/O#8 – Analog input 1	x308	I/O#31 – Dallas ID 4	x331
I/O#9 – Analog input 2	x309	I/O#32 – Dallas Temp. 4	x332
I/O#10 – Profile	x310	I/O#33 – Fuel Counter	x333
I/O#11 – Battery voltage	x311	I/O#34 – Ignition	x334
I/O#12 – Battery Current	x312	I/O#35 – RFID ID	x335
I/O#13 – GPS PDOP	x313	I/O#36 – LLS #1 temp.	x336
I/O#14 – GPS HDOP	x314	I/O#37 – LLS #1 meter	x337
I/O#15 – Ext. Voltage	x315	I/O#38 – LLS #2 temp.	x338
I/O#16 – GNSS Status	x316	I/O#39 – LLS #2 meter	x339
I/O#17 – Movement sensor	x317	I/O#40 – LLS #3 temp.	x340
I/O#18 – Odometer	x318	I/O#41 – LLS #3 meter	x341
I/O#19 – GSM Operator	x319	I/O#42 – LLS #4 temp.	x342
I/O#20 – Speed	x320	I/O#43 – LLS #4 meter	x343
I/O#21 – iButton ID	x321	I/O#44 – LLS #5 temp.	x344
I/O#22 – GSM Signal	x322	I/O#45 – LLS #5 meter	x345

6.3.1.6 K Line parameters

Table 32 CAN elements and parameters

Name	Parameter Name	Configuration ID	Available Values
KLINE Driver Recognize	Priority	X050	0 – disable 1 – low 2 – high
	High level		N/A
	Low level		N/A
	Generate event		3 – Monitoring 5 – On change
KLINE Driver 1 working state	Priority	X051	0 – disable 1 – low 2 – high
	High level		N/A
	Low level		N/A
	Generate event		3 – Monitoring

			5 – On change
KLINE Driver 2 working state	Priority	X052	0 – disable 1 – low 2 – high
	High level		N/A
	Low level		N/A
	Generate event		3 – Monitoring 5 – On change
KLINE Overspeed	Priority	X053	0 – disable 1 - low 1 – high
	High level		N/A
	Low level		N/A
	Generate event		3 – Monitoring 5 – On change
KLINE Driver 1 card	Priority	X054	0 – disable 1 – low 2 – high
	High level		N/A
	Low level		N/A
	Generate event		3 – Monitoring 5 – On change

Name	Parameter Name	Configuration ID	Available Values
KLINE Driver 2 card	Priority	X055	0 – disable 1 – low 2 – high
	High level		N/A
	Low level		N/A
	Generate event		3 – Monitoring 5 – On change
KLINE Driver 1 rel time states	Priority	X056	0 - disable 1 – low 2 – high
	High level		N/A
	Low level		N/A
	Generate event		3 – Monitoring 5 – On change

KLINE Driver 2 rel time states	Priority	X057	0 – disable 1 – low 2 – high
	High level		N/A
	Low level		N/A
	Generate event		3 – Monitoring 5 – On change
KLINE Vehicle speed	Priority	X058	0 – disable 1 – low 2 – high
	High level		0 – 255 km/h
	Low level		0 – 255 km/h
	Generate event		0 – On range exit 1 – On range entrance 2 – On both 3 – Monitoring 4 – Hysteresis 5 – On change

Name	Parameter Name	Configuration ID	Available Values
KLINE Odometer	Priority	X059	0 – disable 1 – low 2 – high
	High level		N/A
	Low level		N/A
	Generate event		3 – Monitoring 5 – On change
KLINE Distance	Priority	X060	0 – disable 1 – low 2 – high
	High level		N/A
	Low level		N/A
	Generate event		3 – Monitoring 5 – On change

KLINE Driver 1 ID	Priority	X061	0 – disable 1 – low 2 – high
	High level		N/A
	Low level		N/A
	Generate event		3 – Monitoring 5 – On change
KLINE Driver 2 ID	Priority	X062	0 – disable 1 – low 2 – high
	High level		N/A
	Low level		N/A
	Generate event		3 –Monitoring 5 – On change

To configure Kline Driver 2 ID every parameter should be separated with comma. For example, configuring first profile Kline Driver 2 ID by SMS, SMS should look like: “ setparam 1062 1,0,,3” (“ setparam 1062 <Priority>,<HighLevel>,<LowLevel>,<generateEvent>”) Other Kline properties can be configured in the same logic.

6.3.1.7 Configurable parameter values and Global parameter values

6.3.1.7.1 Configurable parameters

Table 33 Configurable parameter values

Parameter	ID	Parameter value				Value type
		MIN	MAX	Default	Recommended	
System parameters (chapter 6.3.1.1)6.3.1.1						

Sleep Mode (0 – disable, 1 – enable, 2 – Deep Sleep)	x000	0	2	0	-	U8
Sleep Timeout	x001	0	9000	1	-	U16
Data Acquisition parameters (chapter 8)						
Records :	x010					
Min Period (in seconds)		0	9999999	600	-	U32
Min Distance (in meters)		0	65535	0	-	U32
Min Angle (in degrees)		0	180	0	-	U16
Min Speed (in km/h)		0	400	0	-	U16
Min Speed Source		0 (from GPS)	1 (from LVCAN)	0	-	U8
Min Saved Records		1	25	10	1	U8
Min Send Period (in seconds)		0	9999999	600	-	U32
Configuring format:	<minperiod>,<mindistance>,<minangle>,<minspeed>,<minspeedsource>,<minsavedrecs>,<sendperiod>					

GPRS Week Time	x016	-	-	-	-	-
Geofencing parameters (chapter 6.3.1.3.4.1)						
Frame Border (in meters)	x020	0	9999999	1	1000	U32
Geofence Zone #1	x030					
Zone #1 Shape		0 (Circle)	1 (Rectangle)	0	-	U32
Zone #1 Priority (0 – Low, 1 – High, 2 – Panic, 4, 5, 6, 7 – SW21, SW22, SW23, SW24)		0	7 (exl. 3)	0	-	U8
Zone #1 Generate Event (0 – no event, 1 – on enter, 2 – on exit, 3 – on both)		0	3	0	-	U8
Zone #1 Longitude X1 (Rectangle) / X (Circle)		-180	180	0	-	Float
		-180	180	0	-	Float

Zone #1 Latitude Y1 (Rectangle) / Y (Circle)		-90	90	0	-	Float
		-90	90	0	-	Float
Zone #1 Longitude X2 (Rectangle) / R (Circle)		-180	180	0	-	Float
		0	180 / 9999999.99	0	0	Float
Zone #1 Latitude Y2 (Rectangle) / None (Circle)		-90	90	0	-	Float
		-	-	-	-	-
Configu ring format:	<shape>,<priority>,<generateEvent>,<fx1>,<fy1>,<fx2>,<fy2>					
Geofenc e Zone #2	x031					
Geofenc e Zone #3	x032					
Geofenc e Zone #4	x033					
Geofenc e Zone #5	x034					
Geofenc e Zone #6	x035					
Geofenc e Zone #7	x036					
Geofenc e Zone #8	x037					
Configured same as Geofence Zone #1						

Geofence Zone #9	x038					
Geofence Zone #10	x039					
Geofence Zone #11	x040					
Geofence Zone #12	x041					
Geofence Zone #13	x042					
Geofence Zone #14	x043					
Geofence Zone #15	x044					
Geofence Zone #16	x045					
Geofence Zone #17	x046					
Geofence Zone #18	x047					
Geofence Zone #19	x048					
Geofence Zone #20	x049					
AutoGeofencing parameters (chapter 6.3.1.3.4.2)						
Autogeofence	x290					
Deactivate By		0 (Ignition)	1 (iButton)	0	-	U8

Activation Timeout (in seconds)		0	65535	60	60	U16
Priority (0 – Disabled, 1 – Low, 2 – High, 3 – Panic, 4, 5, 6, 7 – SW21, SW22, SW23, SW24)		0	7	1	1	U8
Event Generating (0 – no event, 1 – on enter, 2 – on exit, 3 – on both)		0	3	0	2	U8
Radius (in meters)		0	9999999	100	100	U32
Configuring format:	<deactivateBy>,<tmo>,<priority>,<eventGenerating>,<radius>					
iButton List (chapter 6.3.1.3.5)						
Authorized iButtons	500-999	0	FFFFFFFF FFFFFFFF		-	U64
Features parameters (chapter 5.6)						
Ignition source	x900	0	1	0	-	U8
High Level (for Ignition)	x901	0	30000	0	-	U16

Low Level (for Ignition)	x902	0	30000	0	-	U16
Eco/Green driving parameters (ID=x910)						
Eco driving type (0 - Disable, 1 - No DOUT control, 2 - DOUT1 control, 3 - DOUT2 control, 4 - DOUT3 control, 5 - DOUT4 control)		0	5	0	-	U8
Eco source		0 (accelerometer)	1 (GPS)	0	-	U8
Max Acceleration Force		5	100	22	25	Float
Max Braking Force		5	100	25	35	Float
Max Cornering Force		5	100	21	-	Float
Acceleration Active Output Duration		0	100	1	-	Float
Braking Active Output Duration		0	100	1	-	Float

Cornering Active Output Duration		0	100	1	-	Float
Configuring format:	<Eco driving type>,<Ecosource><MaxAcceleration>,<MaxBraking>,<MaxCornering>,<AccOutputDuration>,<BrakingOutputDuration>,<CorneringOutputDuration>					
Overspeeding parameters (ID=x911)						
Overspeeding mode (0 - Disable, 1 - No DOUT control, 2 - DOUT1 control, 3 - DOUT2 control, 4 - DOUT3 control, 5 - DOUT4 control)		0	5	0	-	U8
Max Allowed Speed		0	300	90	-	U16
Configuring format:	<Overspeeding mode>,<MaxSpeed>					
Immobilizer (ID=x912)						
Immobilizer mode (0 - Disable, 1 - No DOUT control, 2 - DOUT1 control,		0	5	0	-	U8

3 – DOUT2 control, 4 – DOUT3 control, 5 – DOUT4 control)						
iButton List checking		0 (Disable)	1 (Enable)	0	-	U8
Ignition Timeout		1	255	30	-	U16
Configuring format:	<ImmobMode> <button_enable><TMO>					
Excessive Idling (ID=x913)						
Excessive Idling		0 (Disable)	1 (Enable)	0	-	U8
Time to stationary		0	255	1	-	U16
Time to movement		0	255	1	-	U16
Configuring format:	<Enable>,<Time to stationary>,<Time to movement>					
Trip parameters (ID=x280)						
Trip Enable (0 – disable, 1 – enable)		0	1	1	-	U8
Start Speed		0	255	5	-	U8
Ignition Off Timeout		0	65536	60	-	U16
Configuring format:	<Enable>,<StartSpeed>,<IgnitionOffTimeout>					
GPRS parameters (ID=x240)						

Server Response Timeout		5	300	5	-	U16
GPRS Content Activation (0 – disable, 1 – enable)		0	1	0	-	S8
Domain		Empty	56 char	Empty	-	-
Target Server Port		0	65535	0	-	U16
Protocol (0 – TCP, 1 – UDP)		0	1	0	-	U8
Configuring format:	<Enable>,<IP>,<port>,<protocol>,<Server Reponse Tmo>					
GPRS limit parameters (ID=x241)						
Enable GPRS limits (0 – disable, 1- enable)		0	1	0	-	U8
Data limit Home		1	10000	100	-	U16
Data limit Roaming		1	10000	10	-	U16
Configuring format:	<Enable>,<Data Limit Home>,<Data Limit Roaming>					
Other GSM parameters						
SMS data sending settings (0 – disable, 1 – enable)	x250	0	1	0	-	S8

SMS Login	x252	Empty	5 char	Empty	-	S8[5]
SMS Password	x253	Empty	5 char	Empty	-	S8[5]
Authorized phone numbers	x260-x269	Empty	16 char	Empty	-	S8[17]
Operator Code	x271	0	99999999	0	-	U32
SMS Data send week time schedule	x273	Binary decoding	Binary decoding	-	-	20 byte array

This parameter manages when it is allowed to open GPRS context. When module starts it is prohibited to open the context. When modem's GPRS context is closing (for example changing network) it is allowed to open it only at a defined time. It is possible to allow connections every 10 minutes up to once per day.

Example value: 7F,FF,FF,FF,FF,FF,FF,FF,FF,FF,FF,FF,FF,FF,FF,FF,FF,FF,FF,FF

Schedule parameter format:

Time is defined as 19 byte array ('getparam' 1545 returns 20 bytes). First byte of array defines week days; the rest 18 bytes define timestamps with 10 minute interval. In first byte, first bit (LSB) defines if module should connect to GPRS (send SMS) on Monday, second bit – on Tuesday and so on up to seventh bit – which means Sunday. Eighth bit (MSB) is not used. If bits value is 0 then device is not allowed to open GPRS context, but if it is already open – does not close it. If value is 1 it will work as day minutes are defined in rest of the bytes. Day's minutes are defined by 18 bytes (144 bits). Every nth bit (beginning from the first bit (LSB) and ending 18 bytes 8th bit (MSB)) indicates every 10th minute of the day (day has 1440 minutes).

Sample: GPRS will be allowed on Monday to Friday at 8:00 and 16:00 GMT. The following value should be configured:

00011111 00000000 00000000 00000000 00000000 00000000 00000000 00000001 00000000 00000000
00000000 00000000 00000000 00000001 00000000 00000000 00000000 00000000 00000000

Red bits indicate that GPRS will be allowed every day except Saturdays and Sundays. Blue bits indicate 480 and 720 minutes (480min = 8h and 720min = 16h). So the parameter value should be: 1F,00,00,00,00,00,00,01,00,00,00,00,00,01,00,00,00,00,00,00

It should be sent as UTF8 encoded string.

6.3.1.7.2 Global and External devices parameters

Table 34 Global parameters values

Parameter	ID	Possible Parameter Value	Default Value
-----------	----	--------------------------	---------------

Profile Change On Event	100	0/1 (0 – disable, 1 – enable)	0
Prefered records saving destination	101	0/1 (0 – internal memory, 1 – SDcard)	10
Analog Input 1-2 Type	105	0/1 (0 – 10 V, 1 – 30 V)	0
Static Navigation On/Off	107	0/1 (0 – disable, 1 – enable)	1
Records Sorting	108	0/1 (0 – from newest, 1 – from oldest)	0
Active Data Link Timeout	109	0 – 259200 (time in seconds)	5
Accelerometer Filter Start Value	112	1 – 10 (time in seconds)	1
Accelerometer Filter Stop Value	113	1 – 255 (time in seconds)	30
Continious Odometer	114	0/1 (0 – disable, 1 – enable)	0
J1708 Enable parameter	115	0/1 (0 – disable, 1 – enable)	0
GNSS Satellite System	116	0/1/2/3/4 (0 – all available, 1 – GPS, 2 – GLONASS, 3 – GNSS (all available) + SBAS, 4 – GPS + SBAS)	0
Garmin Ping	117	0/1 (0 – disable, 1 – enable)	0
Garmin Unicode	118	0/1 (0 – disable, 1 – enable)	1
Com1 baudrate	119	0 – 115200	
COM1 Mode	120	0-255 (5 - Silent,97 – LLS Mode,98 – LCD Mode, 99 – RFID Mode, 100 – RFID MF7 Mode, 101 – Garmin Mode, 161 – COM TCP Link Mode, 177 – COM TCP Link Mode Binary, 203 – DTO 1731, 204 –SE500, 10-11 – reserved)	0
GNSS TMO For NTP	121	0-300	0
COM2 Baudrate	122	0 – 115200	5
COM2 Mode	124	0 – 255 (5 - Silent, 13 - FM Log, 15 – NMEA, 97 - LLS, 98 - LCD, 99 - RFID, 100 - RFID M7, 101 - Garmin, 161 - COM TCP Link, 177 - COM TCP Link binary)	115200
COM1 Timestamp	151	0/1 (0 – disable, 1 – enable)	0
COM1 CMD ID	152	0 – 255	0
COM2 Timestamp	151	0/1 (0 – disable, 1 – enable)	10
COM2 CMD ID	152	0 – 255	3
Network Ping Timeout	155	0 – 30 (time in minutes)	0
Data saving without time synchronization	157	0/1 (0 – disable, 1 – enable)	0
Tachograph ignition source	158	1/2/3/4	3
SMS Event number	222-231	string	„“
RS485 Activate	232	0/1	0
RS485 Baudrate	233	0 – 115200	115200
RS485 Mode	234	0 – 255 (5 – Silent, 13 – Log mode, 15 – NMEA, 97 – LLS Mode, 161 – TCP link mode, 171 – Binary mode)	5

SIM1 GPRS APN	240	All character range	
SIM1 GPRS USER	241	All character range	
SIM1 GPRS PASS	242	All character range	
LLS 1-5	256-260	0,255	0
SMS event data min-max	300-499	SMS Events	

Configuring SMS event by SMS there is special SMS format:

SMS Format: setparam X Y,W,Z

X – ID

Y – Enable/Disable (1/0)

W – Telephone number INDEX (0 – 9)

Z – SMS Text

Example: “ setparam 300 1,5,Digital Input 1 Event!”

7 PROFILE SWITCHING

FM6320 has 4 profiles saved in Flash memory of the module. Every profile has a list of parameters, which enables FM6320 to operate in different modes while using different profiles. The easiest way to understand what is a profile is to compare it to a list of instructions that are written for different cases. You are allowed to setup up to 4 different module behaviours. Global parameters and external devices contain settings that are common for all 4 profiles. This means that if you set FM6320 to call to a predefined number, you will be able to call it while using any profile. Basic scheme of Global parameters, external devices and profiles is shown below. According to the scheme, every profile has a list of parameters. Global parameters and external devices are common for all profiles. (Figure 30)

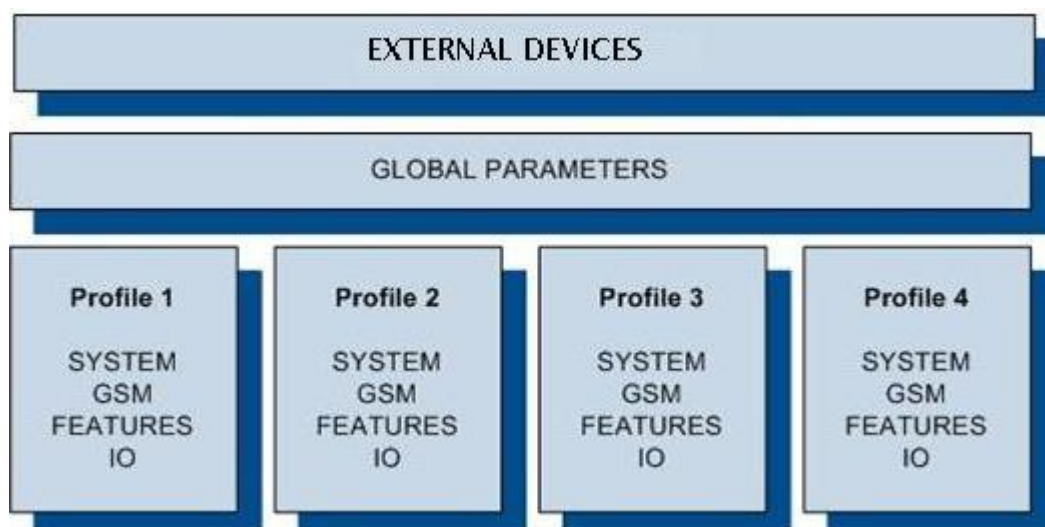

Figure 30 FM6320 profile structure

Switching between profiles (changing behaviour) can be performed by Profile switch depending on GSM operator code (mostly used for roaming applications), or by Profile switch depending on I/O event (on I/O value changing).



Profile 3 is default profile for FM6320. It is always loaded on the very first start-up and further profile switching is proceeded after operator scan or I/O element changes (although device remembers which profile it used after that).

7.1 Profile Switching dependence on GSM Operator

GSM Operator code profile switching is mostly used in roaming applications, when the purpose is to have information from module both from Home and Roaming operator network for a reasonable price. This method allows you to define different module behaviour in Home network, Roaming network and unknown operator areas. See figure below for details.

Profile 1 is configured for home network. Data acquisition and send intervals are quite frequent here. To make profile use effective, it is wise to set more optimized parameters in roaming profile (Profile 2) – this usually includes larger coordinate recording intervals, packets with greater number of coordinates sending, and in some cases GPRS context available only for a certain time interval. Profile 3 can either contain operator codes (rarely used) or have an empty list. Profile 4 is not used (profile 4 can only be used when FM6320 encounters a 'panic' priority event (see 7.2 chapter)).

In the example (Figure 31) FM6320 connects to operator with code 24702. It checks profile 1 operator list, but there is only one operator code entered which does not mach. Then it checks profile 2 operators list. This code is entered there, so FM6320 switches to profile 2.

If there are no operator codes entered in all profiles after operator search task FM6320 will check all 3 profiles and won't find any operators in any list. In such a case, FM6320 will switch to profile 3. Note that before switching to profile 3, the device closes the GPRS session.



Operator search is performed every 15 minutes. If no operators are entered in any profile it can have influence on GPRS sessions. IF GPRS sessions are attaching/detaching every 15 minutes it means configuration of FM6320 is performed incorrectly.

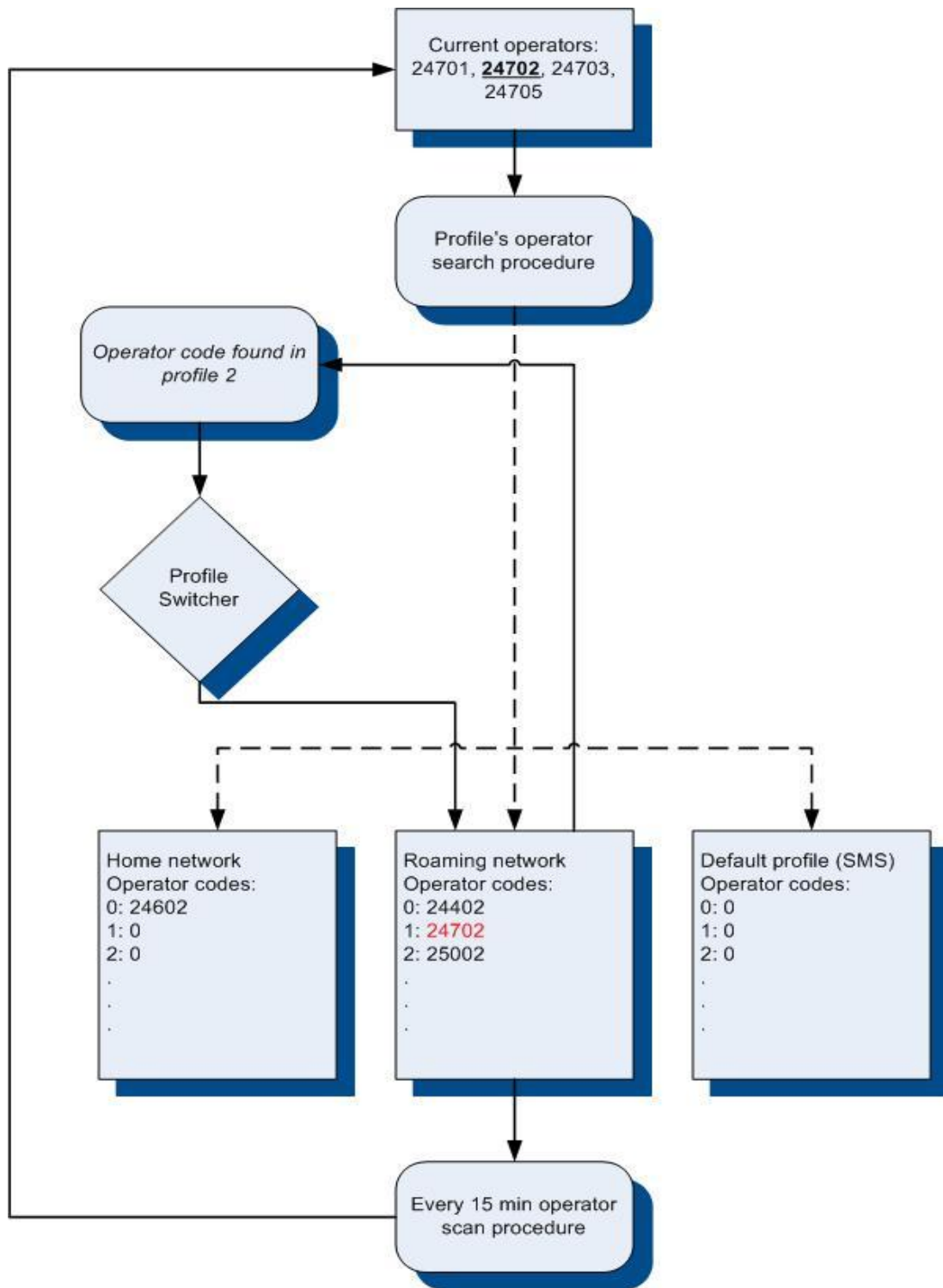

Figure 31 GSM Operator code profile switching (...)

7.2 Profile switching dependence on I/O event

Another profile switch method is based on I/O event. Events happen when the value of enabled I/O intersects thresholds (enter, exit, on both, hysteresis) predefined by High and Low level thresholds. SW21, SW22, SW23, SW24 stands for "Switch to profile No. X". After an event happens, FM6320 switches to a defined profile. Using profile switching you can create smart applications. SW2X actions can be performed only if "Profile change on event" is enabled in Global parameters. Pictures below illustrate profile switching depending on digital events:

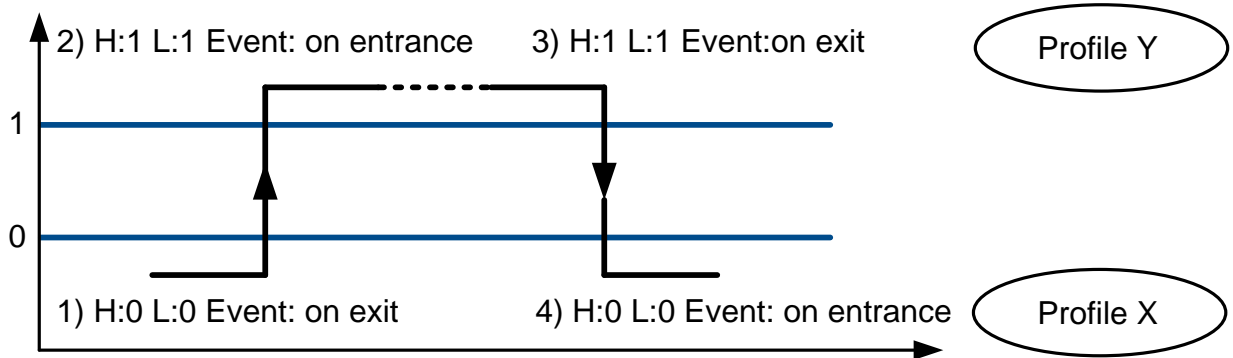

Figure 32 Digital input event criteria

Example #1

Configuration of Profile1 to switch to Profile2 on DIN1 value change from 0 to 1:

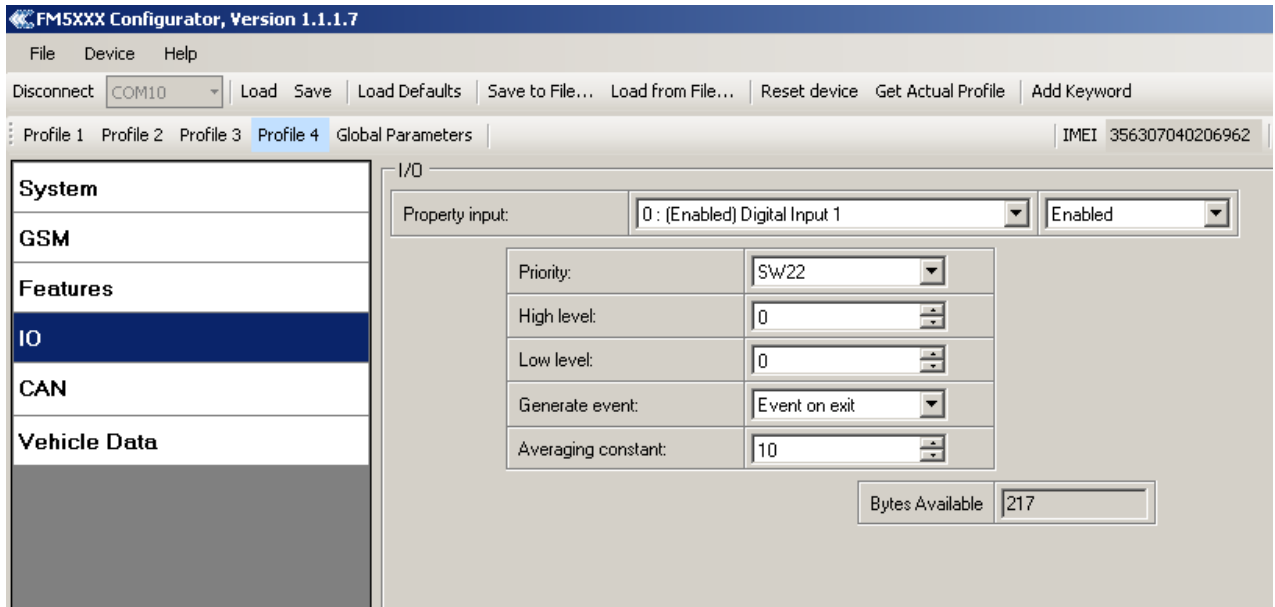

Figure 33 Switch to profile on event (1)

Example #2

Configuration of Profile2 to switch to Profile1 on DIN1 value change from 1 to 0:

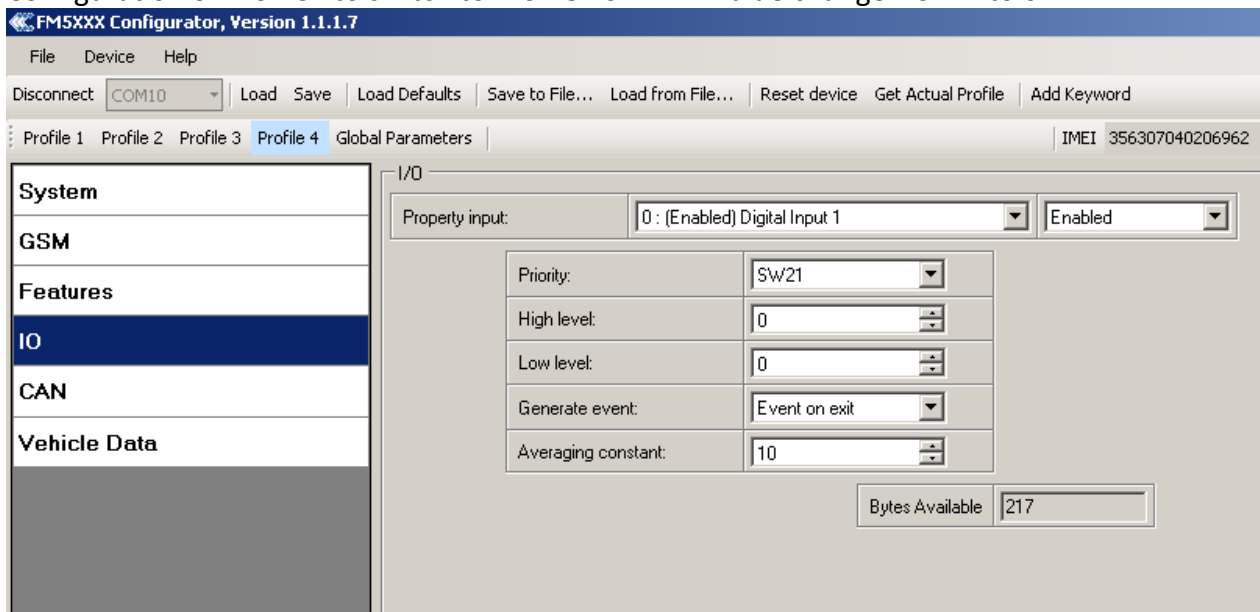

Figure 34 Switch to profile on event (2)

8 DATA ACQUISITION

Data can be acquired using GPS or I/O elements. GPS data is for basic vehicle tracking, data acquisition by I/O elements gives more specific information.

8.1 GPS data acquisition

There are four ways of GPS data acquisition which are configured in *Features > sMode* menu (Figure 35).

Device checks angle, distance, time and speed differences with last saved record. If differences are greater than configured a record is generated. Checking sequence: first angle is checked then distance then time differences and last – speed differences.

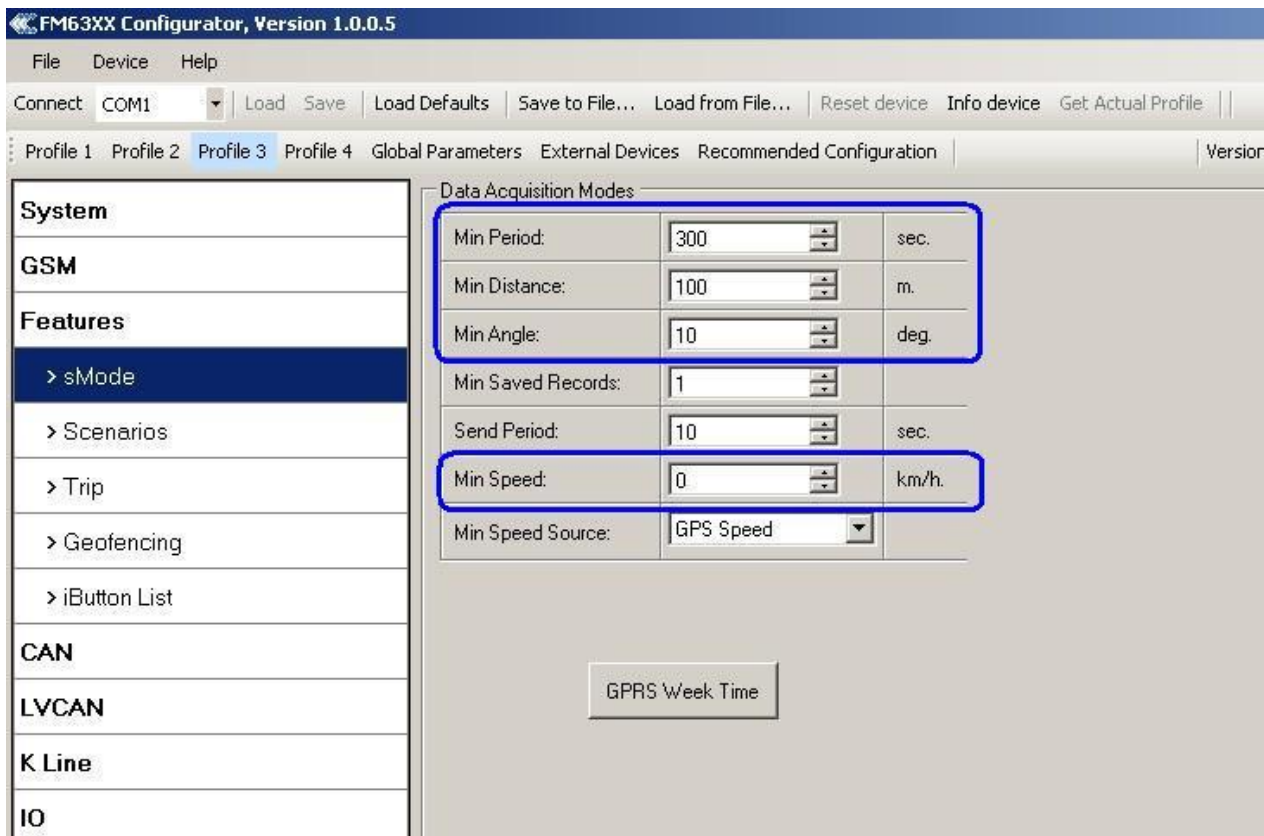

Figure 35 GPS acquisition configuration window

Actual configuration parameters are marked in blue.

Min. Period

Time based data acquiring (Figure 36) – records are being acquired every time when defined interval of time passes. Entering zero means that data will not be recorded according to time. This method is suitable best for basic position update.

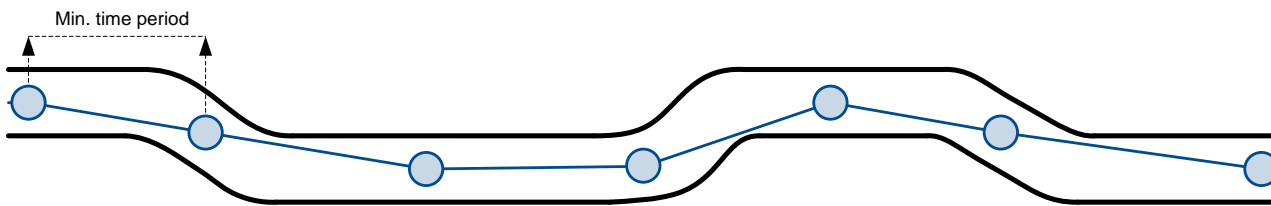

Figure 36 Time based tracking

Min. Distance

Distance based data acquiring (Figure 37) – records are being acquired when the distance between previous coordinate and current position is greater than defined parameter value. Entering zero means that data won't be recorded. This method is suitable for non-urban territories where moving trajectory is straight.

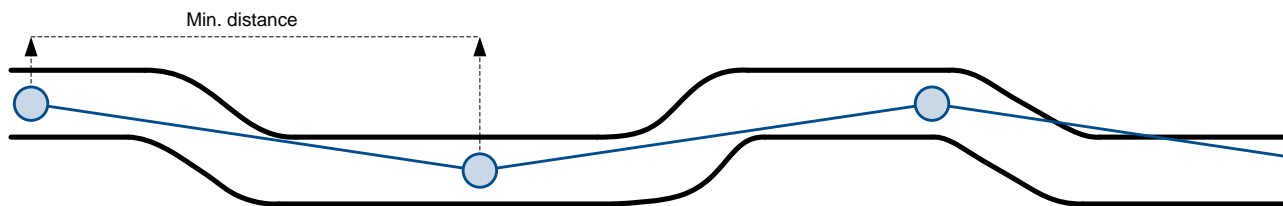

Figure 37 Distance based tracking

Min. Angle

Angle based data acquiring (Figure 38) – records are being acquired when angle difference between last recorded coordinate and current position is greater than the defined value. Entering zero disables data acquisition depending on angle. This method is suitable for urban territories. Note that record generation by angle is performed if vehicle is moving at least 6 km/h.

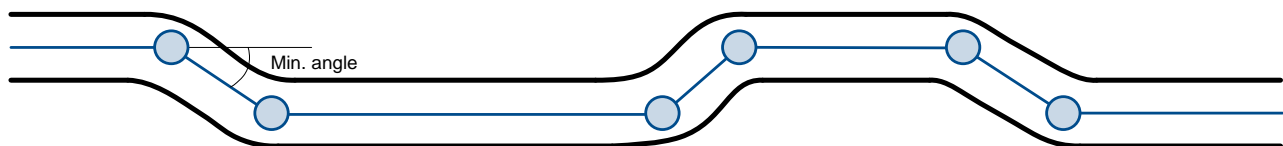

Figure 38 Angle based tracking

Min. Speed

Speed based data acquiring (Figure 39) – records are being acquired when speed difference between last recorded coordinate and current position is greater than the defined value. Entering zero disables data acquisition depending on speed. This method is suitable for urban territories.

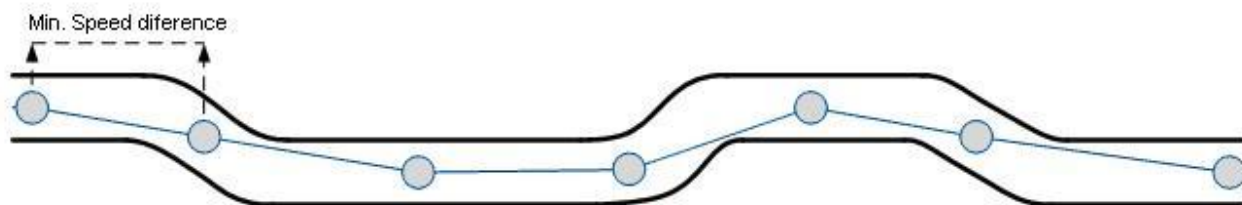

Figure 39 Speed based tracking

8.2 I/O data acquisition

Data also can be acquired using input output elements (it's change). All base elements are declared in Table 23 PERMANENT I/O elements list description and in Table 24 EVENTUAL I/O elements list description

Configuration

Data acquisition by I/O elements can be configured selecting I/O menu in configurator (refer to chapter 6.3.1.5.2).

Priority: Low – as a regular data; High – generated record are sent immediately to server; Panic - generated record are sent immediately to server and simultaneously the same record as SMS message;

High Level: High range of value input;

Low Level: Low Range of value input;

Averaging constant: (see detailed description in chapter 6.3.1.5.2)

Event generation

There are five record event generation type examples (I/O speed is taken as I/O value example), please refer to Figures below.

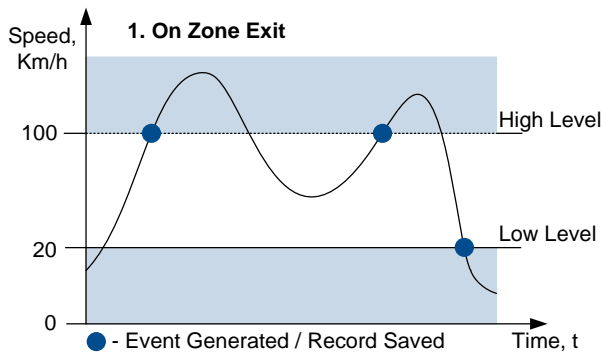

Figure 40 Event On Zone exit

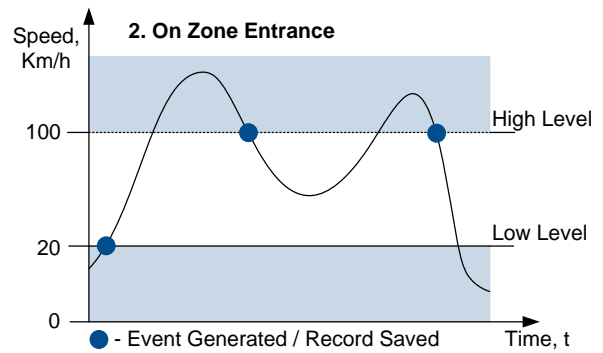

Figure 41 Event On Zone entrance

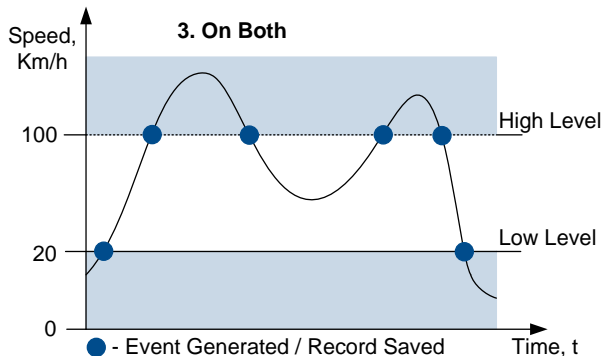

Figure 42 Event On both

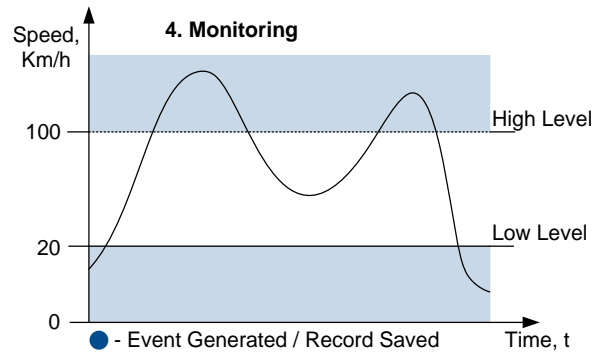

Figure 43 Monitoring

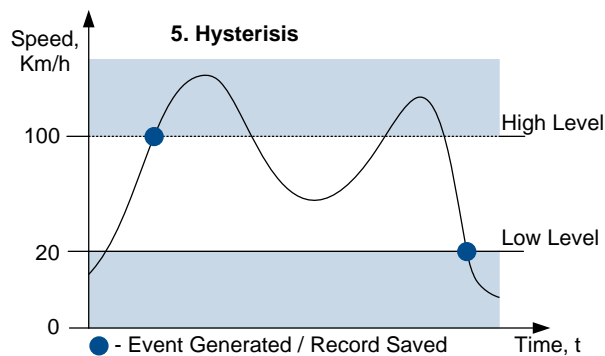

Figure 44 Event on Hysteresis

Event on Zone Entrance: record is generated when actual source value input is between High and Low level ranges which are set in configuration;

Event on Zone Exit: record is generated when actual source value input increases and becomes higher than High level and Low level values;

Event on Both: record is generated when actual source value input increases/decreases and becomes higher/lower than high and low level declared values;

Monitoring: no event at all; I/O values are recorded only when other trigger have worked (GPS acquisition or other I/O trigger)

Hysteresis: record is generated when actual source value input becomes higher than High level value, and decreasing becomes less than Low level value

Event on Change: record is generated on every source value change.

9 DEEP SLEEP MODE

While in deep sleep mode, FM6320 sets GPS receiver to sleep mode and turns off GSM/GPRS module (it is not possible to wake up device via SMS), therefore records with last good coordinates are being saved and sent to AVL server if configured (GSM/GPRS module is turned on to send data and after turned off). Depending on two configurable parameters, send period and min period, in Deep Sleep mode power usage can be decreased to save vehicle's battery.

FM6320 can enter deep sleep mode (standby mode) if **ALL** of these conditions are met:

- FM6320 has to be configured to work in Deep Sleep mode;
- Start-up timeout has elapsed (5 minutes after every restart of the device);
- No movement by accelerometer is detected;
- Ignition is off (driven logic low);
- Send period is more than 60 seconds (Data Acquisition Mode settings);
- USB cable is not connected.

FM6320 exits deep sleep mode if **ONE** of the following conditions are true:

- Movement by accelerometer is detected (depends on accelerometer start settings);
- Ignition is turned on (driven logic high);
- USB cable is connected;
- HIGH or PANIC priority eventual record is detected;

While being in deep sleep mode FM6320:

- can save periodical or eventual records;
- send data to server;



Note: If there is no need to save or send periodical data FM6320 has to be configured to switch to another profile on Deep Sleep Event where Min Period and Send Period parameters are 0 or big enough.



Note: In order to save GPRS traffic records saved in deep sleep mode contain below listed I/O elements information:

Digital Inputs (1-4), Analog Inputs (1-4), Battery Voltage, Battery Current, Digital Outputs (1-4), External Voltage, Movement Sensor, Deep Sleep. Also, Deep Sleep I/O is always LOW PRIORITY!

10 FEATURES AND SCENARIOS

10.1 ECO driving/Green driving Scenarios

Four scenarios are available on FM6320 device. All scenarios can be activated at the same time and all activated scenarios can be configured to control the same DOUT (expect excessive idling).



ECO driving/Green driving Scenarios. Helps to prevent and inspect driver about harsh driving. Eco driving scenario continuously monitors: accelerating, braking and cornering forces depending on build in accelerometer or Green driving depending on GPS. The device inspects driver if needed. Monitoring sensitivity is configurable.

Any of the four DOUT can be configured and then controlled by scenario for user needs, buzzer or LED for example. Output activation time after harsh event is also configurable.

To save GPRS traffic ECO driving/Green driving event will be **generated (included into records) only** when FM6320 measured values are higher than those set in configuration, without additional I/O settings.

To prevent generating false events, harsh acceleration and harsh braking is monitored only when following conditions are fulfilled:

- Ignition is ON
- Vehicle speed is equal or higher than 10km/h

Harsh cornering is monitored only when following conditions are fulfilled:

- Ignition is ON
- Vehicle speed is equal or higher than 30km/h

ECO driving or Green driving Scenario? Eco driving is based on accelerometer value and Green driving based on GPS position.



PLEASE NOTE that Eco Driving functionality generally is dependent on accelerometer. Device must be on plain/horizontal surface to calibrate itself correctly. It calibrates once it is powered up.

Mounting Requirements



PLEASE PAY ATTENTION, that ECO driving functionality will operate correctly only if device is mounted into the vehicle in a proper position.

ECO driving functionality operation is based on accelerometer. It is important to mount FM6320 device correctly to avoid functionality malfunctions (first condition). In the picture below (Figure 45) mounting recommendations are displayed. Please **note** that beside those recommendations

1. You can choose how FM6320 is deployed. It means that that there is no effect to measurements if FM6320 top/bottom side points up or down.
2. Device can be deployed at any place in the car.

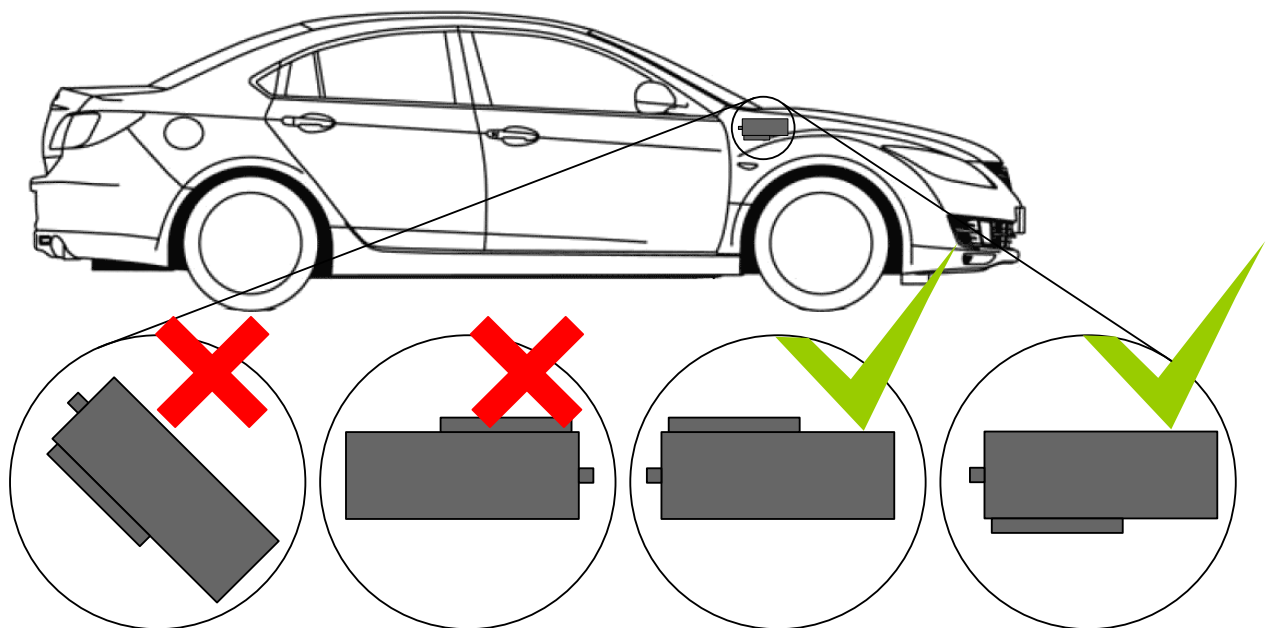

Figure 45 Correct mounting position of the FM6320 in the vehicle

For ECO driving to work properly, device connection pins socket must point towards the vehicles front side. Deviations of $\pm 2^\circ$ are allowed. But it should be as straight as possible.

Deviations of maximum $\pm 15^\circ$ are allowed (Figure 46).

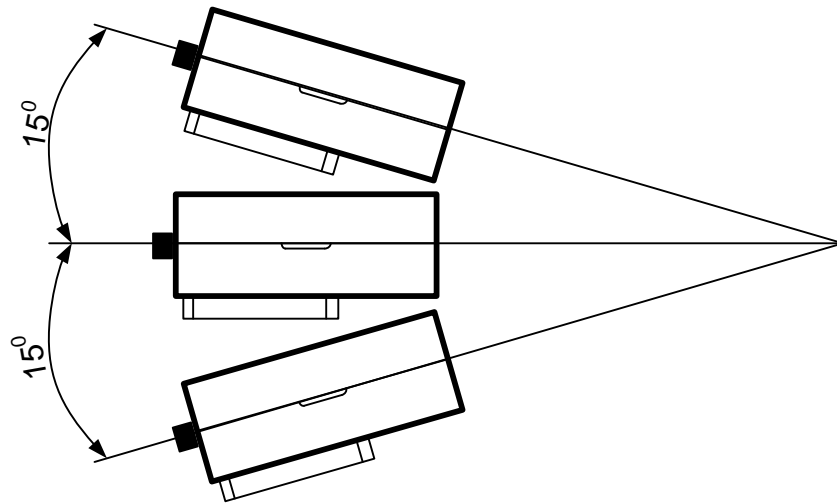

Figure 46 MAX deviation from horizontal plane of FM6320 mounting

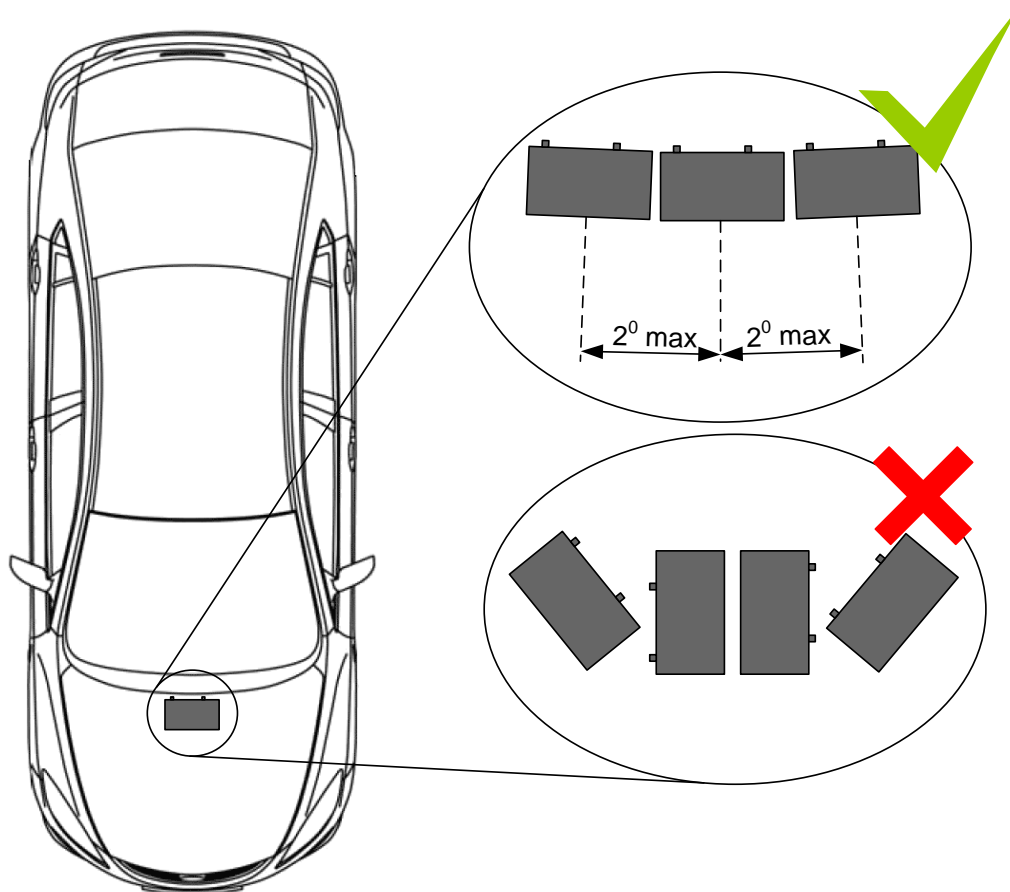
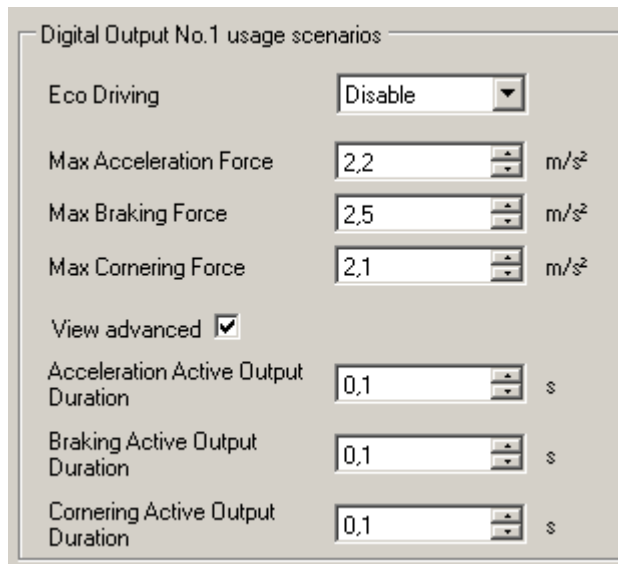

Figure 47 Horizontal position MAX deviation of FM6320 mounting

Horizontal position must be as flat as possible – parallel with vehicle plain.

Configuration

Parameters used with ECO driving/Green driving functionality.



Digital Output No.1 usage scenarios

Eco Driving: Disable

Max Acceleration Force: 2,2 m/s²

Max Braking Force: 2,5 m/s²

Max Cornering Force: 2,1 m/s²

View advanced

Acceleration Active Output Duration: 0,1 s

Braking Active Output Duration: 0,1 s

Cornering Active Output Duration: 0,1 s

Figure 48 ECO driving/Green driving configuration parameters

Table 35 ECO driving/Green driving parameters description

ECO driving/Green driving configuration parameter name	Description
ECO driving type	Selects which DOUT will control scenario
Data source	Selects from where data will be taken
Max Acceleration Force	Value which can be reached while accelerating without triggering harsh acceleration event.
Max Braking Force	Value which can be reached while braking without triggering harsh braking event.
Max Cornering Force	Value which can be reached while cornering without triggering harsh cornering event.
Acceleration Active Output Duration	Set active output duration after harsh acceleration event detected
Braking Active Output Duration	Set active output duration after harsh braking event detected
Cornering Active Output Duration	Set active output duration after harsh cornering event detected

Data output

ECO driving/Green driving functionality generates events on three cases. If vehicles:

- Acceleration exceeds defined parameter value
- Deceleration (braking) exceeds defined value
- Cornering force exceeds defined value

Program continuously monitors and process data from accelerometer than decides whether harsh event is detected or not. If any of three cases are satisfied event is generated. Record is saved and sent to server (FM6320 must be configured properly). Event value is multiplied by 10 before sending/saving record to get more precision when displaying **data***.

Digital output No.1 is activated for a period of time to warn driver. Output on-time should/can be configured separately for each case.

***Example.** If acceleration harsh event of 3.55 m/s² detected. Record with value $3.55 * 10 = 35.5 \approx 36$ will be saved and sent to server.

10.2 Overspeeding Scenario

Overspeeding. Helps to prevent from exceeding fixed speed and inspects driver if needed. DOUT1 is controlled by scenario for user needs, to manage buzzer, LED etc.

Mounting Requirements and Working Conditions

1. All scenarios on corresponding Digital Output can be enabled at once.
2. Ignition must be on.
3. Device module mounting position doesn't have any influence for correct scenario operation.

Configuration

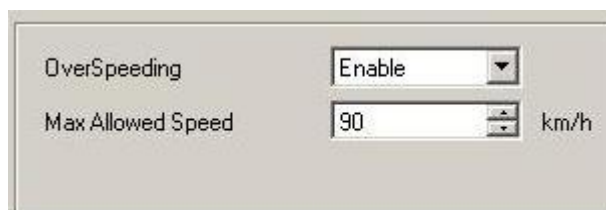

Figure 49 Overspeeding configuration parameters

Overspeeding. Enable/Disable Overspeeding.

Max Allowed Speed. Set speed limit to reach without triggering Overspeeding event.

10.3 Immobilizer/ Authorized Driving Scenario

Immobilizer (iButton list checking disabled). Vehicle can be used only if iButton is connected. In this scenario iButton list is not used; connect any iButton to pass Immobilizer security. Selected DOUT is controlled by scenario for user needs.

Configuration

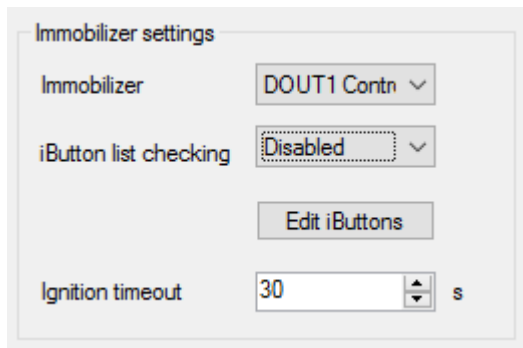

Figure 50 Immobilizer configuration parameters

Immobilizer. Enable/Disable Scenario.

iButton list checking. When Disabled turn on Immobilizer Scenario.

Ignition timeout. Time that need to be passed when ignition (DIN1) turns off to reactivate scenario.

Authorized Driving (iButton list checking enabled). Gives ability to use vehicle for 500 specific iButton owners (specified in iButton list). Selected DOUT is controlled by scenario for user needs, to manage buzzer, LED etc.

Configuration

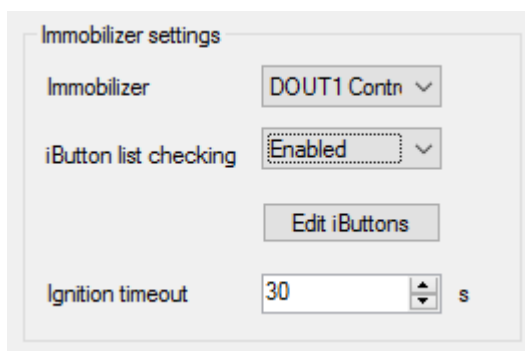

Figure 51 Authorized driving configuration parameters

Immobilizer. Enable/Disable Scenario.

iButton list checking. . When Enabled turn on authorized driving Scenario.

Ignition timeout. Time that need to be passed when ignition (DIN1) turns off to reactivate scenario.

10.4 COM1 and COM2 Working Modes

COM1 is dedicated only for connecting tachograph. Protocols DTCO 1381 and SE 5000 are available

COM2 Working Modes:

Silent Mode

FM6320 doesn't do any activity in silent mode. Logs aren't saved and any data isn't sent.

FM Log Mode

This is default mode of the FM6320. It is suitable for debugging.

LLS Mode

10.4.1.1 LLS Mode Configuration

1. Globals->COM2 Settings->Baudrate = 19200
2. Globals->COM2 Settings->Mode = LLS

Note

COM2: Level will be with ID:203 Temperature will be with ID:204.
On Valid data Receive Status LED will blink.

LCD Mode Configuration

1. External Devices->COM2 Settings->Baudrate = 57600
2. External Devices ->COM2 Settings->Mode = LCD

How to use:

- * From Terminal need send command "WT^W your text here"
- * From Hercules (server) Send "#DO DAT=you text here" (in special packet)

Notes:

#DO DAT= command prints only to COM2

Link between FM and server has to be established for this functionality to work

On Valid data Receive Status LED will blink.

RFID HID Mode Configuration

1. External Devices ->COM2 Settings->Baudrate = 57600

2. External Devices ->COM2 Settings->Mode = RFID
3. External Devices ->COM2 Settings->Parity = Even

RFID MF7 Mode Configuration

1. External Devices ->COM2 Settings->Baudrate = 9600
2. External Devices ->COM2 Settings->Mode = RFID MF7
3. External Devices ->COM2 Settings->Parity = None

Garmin Mode Configuration

10.4.1.2 Settings

1. External Devices ->COM2 Settings->Baudrate = 9600
2. External Devices ->COM2 Settings->Mode = Garmin
3. External Devices ->COM2 Settings->Parity = None

Ping Filter Enable Parameter:

- 0 - [DISABLED] = Ping packet will not be blocked.
- 1 - [ENABLED] = Ping packet will be blocked.

Unicode Support Packet Enable Parameter:

- 0 - [DISABLED] = Unicode Packet will be sent to server.
- 1 - [ENABLED] = Unicode Support Packet will not be sent to server.

10.4.1.3 Firmware Configuration

Supported Garmin protocols: A***

(<http://developer.garmin.com/lbs/fleet-management/fmi-protocol-support-matrix/>)

Blocked Garmin ID's:

- Command 0A
- Date/Time Data 0E
- Unit ID/ESN 26
- Pvt Data 33
- Legacy Stop Message 87
- Legacy Text Message 88
- Ping 0260
- Ping response 0261
- Product ID Request 0001
- Product ID Data 0002

FM send ACK the these packets, and these packets are not sent to server to reduce traffic.

Allowed Garmin ID's:

- ACK 06
- NAK 15
- Fleet Management Packet A1

Note:

If packet are not listed here packet ID will be ignored.

COM TCP Link Mode

In this mode link with external device using text messages can be established.

Any string of data coming to COM will be routed to server. (if link is currently active) First message will be packet to special packet⁶.

If you want to send message to COM, you need to pack in special packet.

1. External Devices ->COM2 Settings->Baudrate = any of available baudrates
2. External Devices ->COM2 Settings->Mode = TCP Link Mode
3. External Devices ->COM2 Settings->Parity = any setting

These parameters are automaticaly configured when TCP Link mode is selected:

- * Record refresh timeout 9999999 sec.
- * ignores weektime, timesync, and records

TCP Link Mode (Binary)

This mode is the same as above but binary message will be accepted to/from COM port.

1. External Devices ->COM2 Settings->Baudrate = any of available baudrates
2. External Devices ->COM2 Settings->Mode = TCP Link Mode

NMEA Log Mode

In this mode NMEA logs are sent via COM2 ports.

⁶ For additional information of special packet, please contact to your local sales representative

11 SMS COMMAND LIST

SMS commands are used to identify FM6320 current state, possible configuration errors, perform reset, set parameters, switch on/off outputs, etc.

SMS commands should be sent along with module login and password and sender number must be entered in the authorized number list (if at least one other number is entered). Please see SMS settings in chapter 6.3.2.2.2 for more details.

SMS structure is as follows:

<login><space><password><space><command>

Example:

opa opa getgps

Table 36 SMS command list and description

Command	Description	Response
getstatus	Modem Status information	Yes
getweektime	Current device time, Day of Week and amount of minutes passed since start of week	Yes
getops	List of currently used and available GSM operators	Yes
readops#	Emergency gsm operator readout from active profile # - 1,2,3 1 – operators [1-20] 2 – operators [21-40] 3 – operators [41-50]	Yes
getnmeainfo	Nmea error debug sms	Yes
getcfgtime	Date and Time of last successful configuration	Yes
getgps	Current GPS data and time	Yes
loadprofile#	Load specified profile into RAM Engine Profile. # - number of profile to load	Yes
cpureset	Reset CPU	No
resetallprof	Reset all FLASH profiles to default profile	Yes
getver	Device / Modem / Code version information	Yes
getinfo	Device runtime system information	Yes
deleterecords	Delete all records saved on FLASH	No
getio	Readout digital inputs and outputs, analog inputs	Yes
radio #	Readout input value according entered ID, # - ID value	Yes
setdigout XXXX Y1 Y2 Y3 Y4	Set digital outputs 0 – OFF, 1 – ON Y1 – timeout for DO1 Y2 – timeout for DO2 Y3 – timeout for DO3 Y4 – timeout for DO4	Yes
getparam #	Readout parameter value according entered ID. # - ID value.	Yes
setparam # #	Set parameter value according entered ID and Value.	Yes

	1.# - ID value. 2.# - New Parameter Value	
flush #,#,#,#,#,#,#	Initiates all data sending to specified target server 1.# - IMEI 2.# - APN 3.# - LOGIN 4.# - PASS 5.# - IP 6.# - PORT 7.# - MODE (0-TCP/1-UDP)	Yes
sn x [x=0;1]	Enable/disable static navigation	Yes
banlist	Banlist information	Yes
crashlog	Crash log information	Yes
delete_all_sms	Delete all read SMS	No
getgnss	Current GNSS information	Yes
odinfo	Current odometer information	Yes
prof2backup	Saves configuration to backup	Yes
backup2prof	Recovers saved profile	Yes
backupinfo	Backup information	Yes

11.1 getstatus

Table 37 getstatus

Response details	Description
Data Link	Indicate module connection to server at the moment: 0 – Not connected, 1 – connected
GPRS	Indicate if GPRS is available at the moment
Phone	Voice Call status: 0 – ready, 1 – unavailable, 2 – unknown, 3 – ringing, 4 – call in progress, 5 – asleep
SIM	SIM Status: 0-ready, 1-pin, 2-puk, 3-pin2, 4-puk2
OP	Connected to GSM Operator: Numerical id of operator
Signal	GSM Signal Quality [0-5]
NewSMS	Indicate if new message received
Roaming	0 – Home Network, 1 – roaming
SMSFull	SMS storage is full? 0 – ok, 1 – SMS storage full
LAC	Location Area Code
Cell ID	Cell ID

Answer Example: Data Link: 0 GPRS: 1 Phone: 0 SIM: 0 OP: 24602 Signal: 5 NewSMS: 0 Roaming: 0 SMSFull: 0 LAC: 0 Cell ID: 0

11.2 getweektime

Table 38 getweektime

Response details	Description
Clock Sync	Indicates system clock synchronization status. 0 – System is not synchronized, 1 – System synchronized
DOW	Day Of Week – indicates current day of week starting from 1 – Monday, 2 – Tuesday, etc.
Time	Indicates current GMT time
WeekTime	Indicates time in minutes starting from Monday 00:00 GMT

Answer Example: Clock Sync: 1 DOW: 4 Time 12:58 Weektime: 6538

11.3 getops

Table 39 getops

Response details	Description
LIST	Returns list of current available allowed operators.

Answer Example: GSM OP LIST: 0. 24602

11.4 readops#

Table 40 readops#

Response details	Description
LIST	Returns acknowledgment of operators in active profile configuration.

11.5 getnmeainfo

Table 41 getnmeainfo

Response details	Description
BChSum	Nmea packets with bad checksum counter.
HAct	Actual HDOP
BT	Nmea packets with bad timestamp counter
BLat	Nmea packets with bad latitude counter
BLon	Nmea packets with bad longitude counter
BSpd	Nmea packets with bad speed counter
BAng	Nmea packets with bad angle counter
GJC	Nmea packets with GPS jumps counter
Rjc	Rejected Nmea packets counter

11.6 getcfgtime

Table 42 getcfgtime

Response details	Description
Date/Time	Returns last performed configuration date and time.

Answer Example: Last Configuration was performed on: 2010.4.15 5:45:19

11.7 getgps

Table 43 getgps

Response details	Description
GPS	Indicates valid (1) or invalid (0) GPS data
Sat	Count of currently available satellites
Lat	Latitude (Last good Latitude)
Long	Longitude (Last good Longitude)
Alt	Altitude, m
Speed	Ground speed, km/h
Dir	Ground direction, degrees
Date	Current date
Time	Current GMT time

Answer Example: GPS:1 Sat:7 Lat:54.71473 Long:25.30304 Alt:147 Speed:0 Dir:77 Date: 2007/8/24 Time: 13:4:36

11.8 loadprofile#

Returns acknowledgment of successful profile changing from currently used to preferred.

Example: Profile Nr.1 successfully changed to Profile Nr.3

11.9 cpureset

Resets cpu – does not send a response back to the sender.

11.10 resetallprof

Resets all FLASH profiles to default profile.

Answer Example: All Profiles Reseted.

11.11 getver

Table 44 getver

Response details	Description
Code Ver	Firmware version
Device IMEI	IMEI
Device ID	Device ID is used to detect which type of configuration to load
BL Ver	Bootloader Version
Modem App Ver	Version of modem application
Hw	Hardware type

Answer Example: Code Ver:01.02.12 Rev:1 Device IMEI:353976010139156 Device ID:000007 BL Ver:05.16 Modem Ver:TM11Q_R_01.03.04.00_004 Hw:Int Bat + GGG + LIS3DH

11.12 getio

Table 45 getio

Response details	Description
DI#	Digital Input state
DO#	Digital Output state
AI#	Analog Input state

Answer Example: DI1:0 DI2:0 DI3:0 DI4:0 AI1:0 AI2:0 DO1:0 DO2:0 DO3:0 DO4:0

11.13 getinfo

Table 46 getinfo

Response details	Description
INI	Device Initialization Time
RTC	RTC Time
RST	Restart Counter
ERR	Error Counter
SR	Number of Sent Records
BR	Number of broken records
CF	Profile CRC Fail counter
FG	Failed GPRS counter
FL	Failed link counter
UT	UPD Timeout counter
P#	Current profile
###;###;#	# - how many times appropriate profile (Profile0; Profile1; Profile2; Profile3; Profile4) was loaded
SMS	Sent SMS Counter
NOGPS	No GPS Timer
GPS	GPS receiver state. 0 – OFF, 1 – restarting, 2 – ON but no fix, 3 – ON and operational, 4 – sleep mode
SAT	Average satellites
RS	Reset Source Identification
RF	Number of records found on FLASH

Answer Example: INI:2007/8/24 10:15 RTC:2007/8/24 12:43 RST:2 ERR:11 SR:182 BR:0 CF:0 FG:0 FL:0 UT: P:1;0;1;0;0;0 SMS:2 NOGPS:0:0 GPS:3 SAT:7 RS:7 RF:11

11.14 deleterecords

Deletes all saved records from device memory. Device does not send a response back to the sender.

11.15 readio

Table 47 readio #

Response details	Description
ID	IO element ID
Value	IO Element value

Answer Example: IO ID:3 Value:0

11.16 setdigout ##### X Y Z W

Sets digital outputs to ON or OFF state (for some time if needed). Value is written as a row for OUT1, OUT2, OUT3, OUT4 values.

Example: 'setdigout 0010 0 0 5 0' will set OUT3 to high level for 5 seconds, while OUT1, OUT3 and OUT4 to low level.

Ans. example: "DOUTS are set to:0010 TMOs are: 0 0 5 0. Out1 Scenario: Enabled Out2 Scenario: Disabled"

11.17 getparam

Read parameter value. ID consists of 4 digits – first digit identifies profile, second, third and fourth identifies parameter ID as described in Parameters Configuration chapter.

Table 48 getparam #####

Response details	Description
ID	Profile number and parameter ID
Value	Parameter value

Example: 'getparam 1245' command will request server IP address in profile1.

11.18 setparam #####

Sets new value for parameter. ID consists of 4 digits – first digit identifies profile, second, third and fourth identifies parameter ID as described in Parameters Configuration chapter. In value field a new parameter value is entered.

Example: 'setparam 1245 127.0.0.1' will change configured IP address in profile1 with new value

11.19 flush #,#,#,#,#,#

Initiates all data sending by GPRS to specified target server. Comma separated parameters go as numbered:

- 1.# - IMEI
- 2.# - APN
- 3.# - GPRS LOGIN
- 4.# - GPRS PASSWORD
- 5.# - IP
- 6.# - PORT
- 7.# - MODE (0-TCP/1-UDP)

Parameters are separated by comma (no spaces needed). In case you do not need to enter parameter (Login/Pass) – do not put space, simply put comma and write next parameter.

Example: opa opa flush 353976012555151,banga,,,212.47.99.62,12050,0

Table 49 flush

Response details	Description
FLUSH SMS Accepted	FLUSH SMS Accepted
# records found on FLASH	Number of records found on FLASH
Minimum Records to Send: #	Number of minimum saved records to send
GPRS Enabled: #	State of the GPRS connection, 0 – disabled; 1 – enabled
Time Sync: #	Indicates time synchronization on the device, 0 – not synchronized; 1 – synchronized

Answer Example: FLUSH SMS Accepted. 11 records found on FLASH. Minimum Records to Send: 1. GPRS Enabled: 1. Time Sync: 1.

11.20 getgnss

Table 50 getgnss

Response details	Description
FIX	GPS fix
SAT GL	Total glonass sattelites
GP	Total gps sattelites

Answer Example: FIX:1 SAT GL:5 GP:10

11.21 sn x

Returns state of static navigation and previous state: Static Nav is Disabled. Was:X or Static Nav is Enabled. Was:X (1 – enabled, 0 – disabled). If sent X is not 0 or 1, then response is: WARNING: Undefined SN parameter: X.

11.22 banlist

Returns a list of possible banned operators. If device returns zeroes, there are no banned operators saved. Format: A.Bs.C.D

Table 51 banlist

Response details	Description
A	Banned operator code
Bs	Time left
C	Reason (GSM or GPRS)
D	Counter (how many times this operator code was already banned)

11.23 crashlog

Returns list of possible device crashes.

11.24 braminfo

Table 52 braminfo

Response details	Description
Boot	Bootloader parameter
Uptime	Device uptime
RST	Device reset counter
IWDF_RST	Independent watchdog reset counter
BadRec	Bad record counter
AD	Authorized driving state
GD	ECO driving/Green driving state
IM	Immobilizer state

11.25 odinfo

Odometer Debug

Table 53 odinfo

Field Name	Full Name	Posible values
E	Odoemter Enable	0-Disable 1-Enabled
V	Odometer Value	0-UINT32_MAX
M:	Mode	0- Differential 1- Continuous
Mv:	Movement	0- Not moving 1- moving
GPS:	GPS Module Status	0-OFF 1-Restarting 2-Ready no FIX 3-Working FIX 4-Sleep
FIX:	GPS FIX	0- No FIX 1- FIX
Valid:	Valid Nmea data	0- Not Valid 1- Valid
Sp:	GPS Speed	[0-350]
Ns:	Nmea Stable Flag	0 – Not Stable 1 –Stable
Jl:	Jump Lock	0- Lock ON 2- Lock OFF
ALong:	Current Longitude	
ALat:	Current Latitude	
OLong:	Odometer Longitude	
OLat:	Odometer Latitude	

Answer Example: E:1 V:300 M:1 Mv:1, GPS:2 FIX:0 Valid:1 Sp:0 Ns:0 Jl:1 ALong:0.000000
ALat:0.000000 OLong:0.000000 OLat: 0.000000

12 CAN

Controller Area Network (CAN or CAN-bus) is a computer network protocol and bus standard designed to allow microcontrollers and devices to communicate with each other and without a host computer. It was designed specifically for automotive applications but is now also used in other areas.

SAE J1939 is the vehicle bus standard used for communication and diagnostics among vehicle components. Based on the same architecture FMS protocol dedicated to telematics systems is available. It has certain standardized parameters available, such as fuel consumption, engine work-hours, etc. Please visit <http://www.fms-standard.com/> for more information and message structure.

The FMS-interface is an optional interface of different truck manufacturers. Supported information is dependent upon vehicle equipment. For the full information set, additional Electronic Control Units (ECU) may be required. Please contact the manufacturer or your dealer for more details.

Vehicle brands supported:

- Mercedes Benz
- Volvo
- MAN
- DAF
- Iveco
- Scania
- Renault

Available parameters:

- Total Fuel
- Total Distance
- Status of brake pedal *
- Engine Torque *
- Actual fuel
- Accelerator pedal position *
- Status engine brake
- Speed *
- RPM
- Engine hours
- Vehicle Weight *
- Fuel level
- Tachograph data *

* Availability of parameter depends on vehicle's model and configuration of FMS interface of the truck.

12.1 General description

- CAN works if no USB cable is inserted and isn't in deep sleep mode;
- Uses six different speeds: 50 kbps, 100 kbps, 125 kbps, 250 kbps, 500 kbps, 1000kbps;
- Auto Baud rate detection;

- Filtering messages (StdId, ExtId) according to configuration;
- Using mask, filters required bytes;
- Different CAN configurations.

12.2 Configuration

Manual CAN data can be configured using “Manual CAN” in CAN tab, figure below (Figure 52 CAN configuration window).

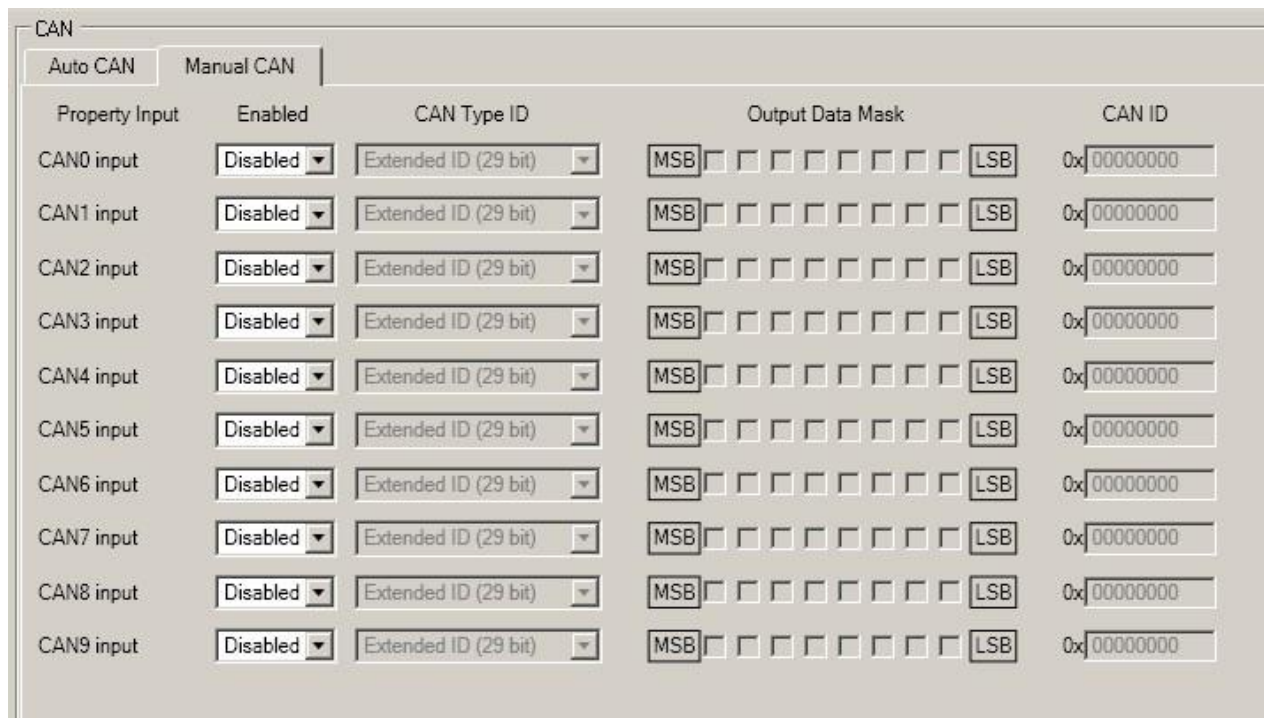

Figure 52 CAN configuration window

CAN message ID type: Message ID type (Figure 53 CAN message ID types) two types according to SAEJ1939 standard: Standard ID (value: 0 to 0x7FFh) and Extended ID (value: 0 to 0x1FFFFFFh).

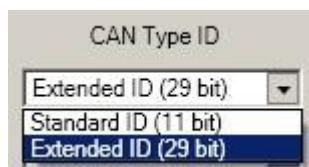

Figure 53 CAN message ID types

Message ID value is entered in hex format. This parameter is used to configure hardware message filter (Figure 54). All messages contain 8 bytes of data, to select particular data/bytes “Output Data Mask” is used, it’s done by ticking required bytes, only selected bytes are sent to server.



Figure 54 CAN message filter configuration

12.3 Example

A sample CAN message has the following structure: X18FEE9018FFFFFFFF23840300, where essential parts are 'FEE9' – identifier and 'FFFFFFFF23840300' – data bytes.

CAN messages are configured like any other I/O parameters. They consist of 4 identifier bytes and 8 data bytes. Below you will find a sample configuration for fuel consumption parameter:

ID type – is always 29 bits.

Output data mask – defines which data bytes are sent to the server (sometimes not all data bytes are necessary).

CAN ID – this is 4 byte identifier. Messages use 4 bytes, but the first and last bytes may differ in different vehicle models while the middle four bytes are the same for all vehicles. The first and last bytes may have any value. Because of this reason it is recommended to write FF in the first byte and the same in the last byte.



This information is provided only as an example and Teltonika takes no responsibility for information accuracy or damage that may be done to the vehicle or FM6320 module while integrating it.

Example:

All Mercedes Benz Actros 2 models with Vehicle Identification Number (VIN) starting with WDB93 have a possibility to connect FM6320 module to CAN bus. This can be done by connecting to special PSM module (which may or may not be included in the truck) or ground module of the vehicle. For CAN signal to be available, parameter 520 must be enabled in "kommunikationsschnittstelle" in the vehicle with Mercedes Stardiagnose.

CAN wires can be found on X5 connector located in the fuse box (Figure 55):

Pin 5: CAN Low signal (yellow wire)

Pin 2: CAN High signal (blue wire)

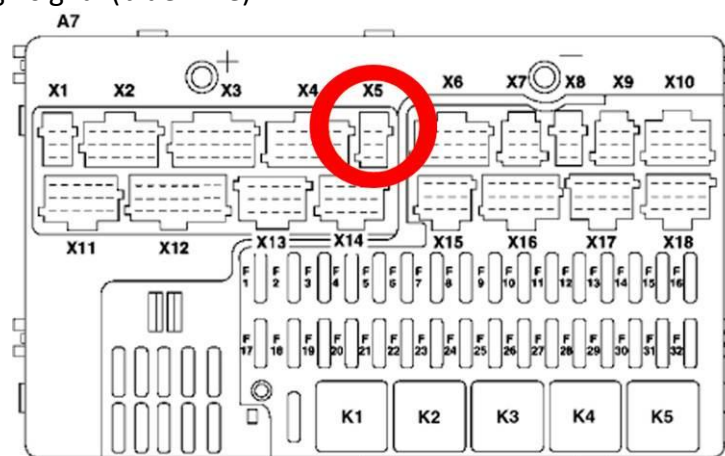

Figure 55 X5 plug on Mercedes Benz

In the example FM6320 will filter all CAN messages with identifier FFEE9FF (fuel consumption) (Figure 56).

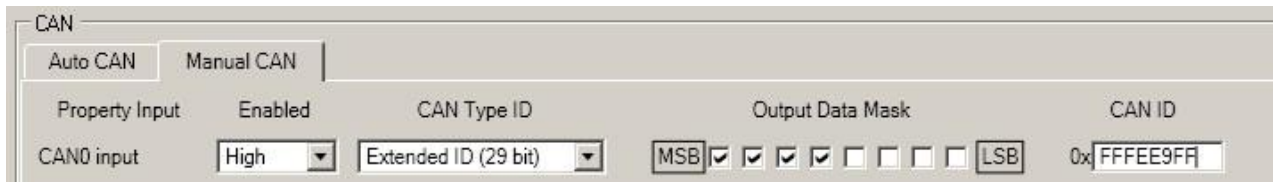

Figure 56 CAN parameter configuration example



Note: Averaging constant cannot be used with CAN data, because this information comes in digital format. So in order to prevent data loss, set Averaging constant parameter to 1.

Most parameters have certain resolution. FEE9 parameter has 0.5L/bit gain, so value that is sent to server has to be multiplied by 0.5.

Data parsing is preceded by selecting correct message from all available on CAN bus. FMS standard interface description indicates that fuel consumption is parameter with ID FEE9:

Table 55 FMS standard – fuel consumption

00FEE9								PGN Hex
65,257								PGN
1000 ms								Rep. Rate
Data Byte 1	Data Byte 2	Data Byte 3	Data Byte 4	Data Byte 5	Data Byte 6	Data Byte 7	Data Byte 8	Byte No.
Not used for FMS-Standard	Not used for FMS-Standard	Not used for FMS-Standard	Not used for FMS-Standard	Total fuel used 0,5 L/Bit gain 0 L offset 5.2.5.66 SPN 250	Total fuel used 0,5 L/Bit gain 0 L offset 5.2.5.66 SPN 250	Total fuel used 0,5 L/Bit gain 0 L offset 5.2.5.66 SPN 250	Total fuel used 0,5 L/Bit gain 0 L offset 5.2.5.66 SPN 250	Name Values Values Values SAE ref SPN

The example indicates how fuel consumption message is selected and how configuration impacts this selection (Figure 57).

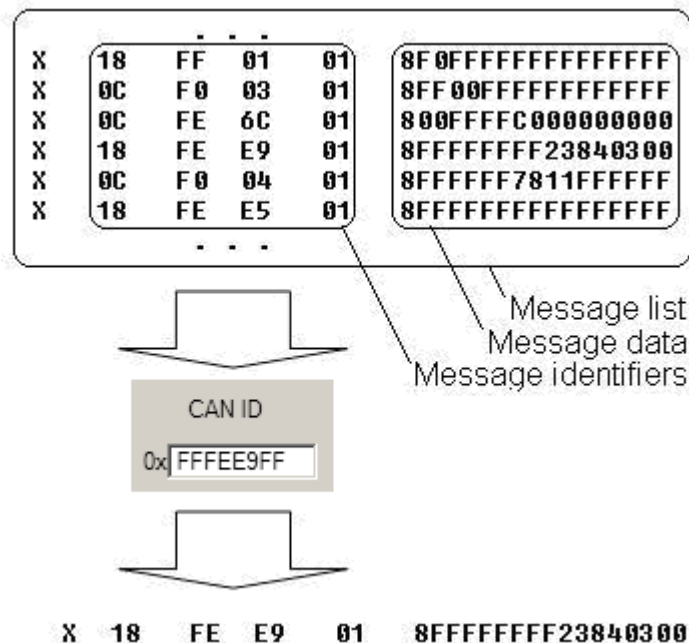

Figure 57 Example

When certain message is filtered, FM6320 checks which data bytes should be sent to server. Document indicates that 5-8 bytes are used in FMS standard.

Table 56 FMS standard – fuel consumption (5-8 bytes)

Data Byte 5								Data Byte 6								Data Byte 7								Data Byte 8								Byte No.
8	7	6	5	4	3	2	1	8	7	6	5	4	3	2	1	8	7	6	5	4	3	2	1	8	7	6	5	4	3	2	1	Bit no
Total fuel used								Total fuel used								Total fuel used								Total fuel used								Name
0,5 L/Bit gain								0,5 L/Bit gain								0,5 L/Bit gain								0,5 L/Bit gain								Values
0 L offset								0 L offset								0 L offset								0 L offset								Values
5.2.5.66								5.2.5.66								5.2.5.66								5.2.5.66								Values
SPN 250								SPN 250								SPN 250								SPN 250								SAE ref
																																SPN

X18FEE9018 FF FF FF FF 23 84 03 00

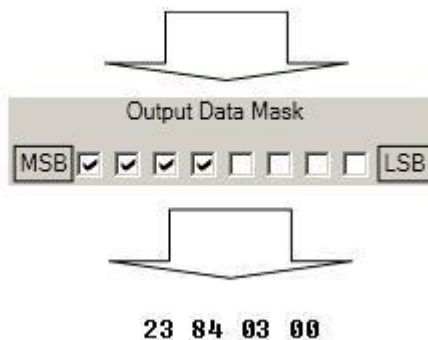

Figure 58 Example

Data bytes are filtered by selecting the checkboxes in Output data mask. Note, that configurator has them listed starting with MSB.

After message is filtered it is attached to the data packet and sent to the server. Values are returned in HEX. 00 03 84 23(HEX) = 230435(DEC). Notice, that data resolution is 0.5L/bit gain – value has to be multiplied by 0.5, therefore vehicle used total of 115217,5 liters of fuel since it

12.4 AutoCAN description

AutoCAN function allows user to automatically scan for available messages on CAN bus and configure CAN data sending to server. In order to configure AutoCAN connect FM6320 to computer with Port ½ cable. Launch FM53xx configurator version 1.1.1.7 or higher. Push “Connect” button, then „CAN“ button (Fig. 58). CAN configuration menu will be opened (Figure 59).

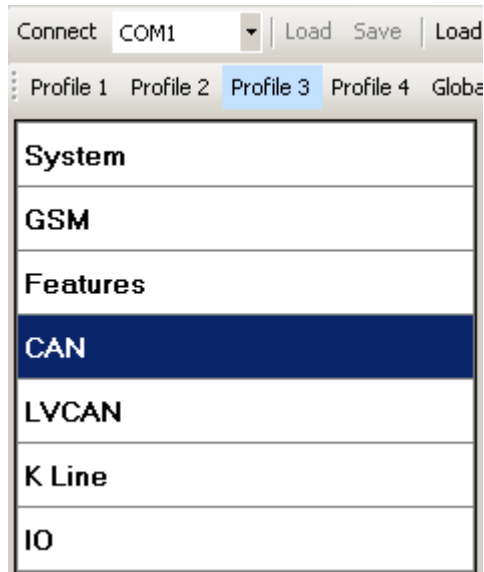

Figure 59 Entering CAN configuration

- SCAN scans once for available messages on CAN bus;
- Monitoring – toggles scanning of messages on CAN bus every 3 seconds;
- Offline Configuration – enables CAN configuration when FM53xx is not connected to CAN bus;
- Auto CAN tab – configure CAN by selecting available messages from CAN bus;
- Manual CAN tab – Configure CAN by manually entering CAN message ID and data mask;

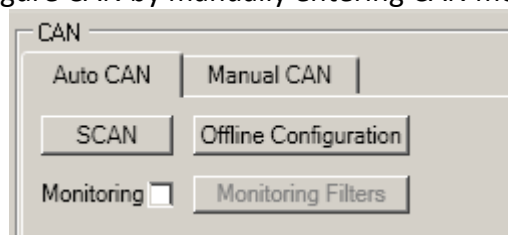

Figure 60 CAN configuration menu

Configuration

To start CAN configuration push “SCAN” button. A table of all available CAN messages will appear (Fig. 63). Description of columns:

- Category – shows CAN message;
- Parameter – shows configurable parameter name;

Figure 61 CAN configuration menu

- Value – shows scanned value of parameter;
- Send data to server – allows to choose the type of data when it’s generated:
 - Disabled – Data will not be collected
 - On low priority – records will be generated as low priority events;
 - On high priority – records will be generated as high priority events and immediately sent to server via GPRS (if GPRS is available);
 - On panic - records will be generated as panic priority events and immediately sent to server via GPRS, if GPRS is not available records will be sent via SMS messages;

- Data acquisition type – allows to choose when records are generated:
 - Monitoring – monitors data;
 - On change – record is generated when parameter value is changed;
 - Hysteresis – record is generated when increasing parameter value becomes higher than High value, and decreasing becomes less than Low value
 - Event on exit – record is generated when parameter value becomes higher than High value or lower than Low value;
 - Event on entrance – record is generated when parameter value becomes between High and Low values;
 - Event on both – record is generated when parameter value crosses High or Low values;
- Low – allows to choose low value for Data acquisition;
- High – allows to choose High level for Data acquisition;

Monitoring filters						
Category	Parameter	Value	Send Data To Server	Data Acquisition Type	Low	High
Cruise Control/Vehicle Speed	Brake switch	Pedal released	Disable	Monitoring		
	Wheel based speed	0 km/h	Disable	Monitoring	0	0
	Cruise control active	Off/disabled	Disable	Monitoring		
	Clutch switch	Pedal released	Disable	Monitoring		
	PTO state	Off/disabled	Disable	Monitoring		
Electronic Engine Controller #2	Accelerator pedal position 1	0 %	Disable	Monitoring	0	0
	Engine Percent Load At Current Speed	0 %	Disable	Monitoring	0	0
Fuel Consumption	Engine total fuel used	0 liters	Disable	Monitoring	0,0	0,0
Dash Display	Fuel level 1	0 %	Disable	Monitoring	1	1
Electronic Engine Controller #1	Engine speed	0 rpm	Disable	Monitoring	0,000	0,000

Figure 62 CAN data table

CAN monitoring

To start CAN bus monitoring mark Monitoring check box. Table of available CAN messages will appear (Fig. 60). Data from CAN bus will be updated every 3 seconds. In order to see only desired data open “Monitoring filters” menu (Figure 63).

Monitoring filters			
Select All		Select None	
<input checked="" type="checkbox"/> Brake switch	<input checked="" type="checkbox"/> Wheel based speed	<input checked="" type="checkbox"/> Cruise control active	<input checked="" type="checkbox"/> Clutch switch
<input checked="" type="checkbox"/> PTO state	<input checked="" type="checkbox"/> Accelerator pedal position 1	<input checked="" type="checkbox"/> Engine Percent Load At Current Speed	<input checked="" type="checkbox"/> Engine total fuel used
<input checked="" type="checkbox"/> Fuel level 1	<input checked="" type="checkbox"/> Engine speed	<input checked="" type="checkbox"/> Axle location1	<input checked="" type="checkbox"/> Tire location1

Figure 63 Monitoring filters

Monitoring filters menu allows choosing which data will be shown in configuration menu. To enable/disable particular data monitoring use checkbox next to data name. To enable all data monitoring push “Select all” button, to disable all data monitoring push “Select none” button.



Note: CAN monitoring is FM6320 configurator function; it does not enable data sending to server. In order to configure data sending to server refer to Configuration section.

Offline configuration

When FM6320 device is not connected to CAN bus you can configure CAN data sending by pushing “Offline configuration” button. When offline configuration is enabled a configuration table of all FMS standard CAN data is shown.

AutoCAN ID list

Table 57 AutoCAN ID list

Category name	Par Nr in P:FMS:	Par Nr. In P:FMSDAT:	(signal) name	Size (Bytes)	Param IO ID	Value range
65265 – Cruise Control/Vehicle Speed	1	1	Brake switch	1	79	0-1 0 = pedal released 1 = pedal depressed
	2	2	wheel based speed	4	80	0-65536 (km/h)*
	3	3	cruise control active	1	81	0-1 0 = switched off 1 = switched on
	4	4	clutch switch	1	82	0-1 0 = pedal released 1 = pedal depressed
	5	5	PTO state	1	83	0-3 0 = off/disabled 1 = Set 2 = not available
61443 – Electronic Engine Controller #2	6	6	accelerator pedal position 1 X	4	84	0-102 (%)*
	7	7	Engine Percent Load At Current Speed X	1	85	0-125 (%)*
65257 – Fuel Consumption	8	8	Engine total fuel used	4	86	0 – 2105540607,5 (Liters)*
65276 – Dash Display	9	9	fuel level 1 X	4	87	1-102 (%)*
61444 – Electronic Engine Controller #1	10	10	engine speed X	4	88	0 – 8031,875 (rpm)*
65258 – Vehicle Weight **	[11-25] (Tire No 1 - 15)	11	Axle location	1		1-15
			Tire location	1		1-15
			Axle weight	4	[89 – 103]	32766 (kg)*
65253 – Engine Hours, Revolutions: HOURS	26	12	Engine total hours of Operation X	4	104	0 – 214748364 (Hours)*

65260 – Vehicle Identification	27	13	vehicle identification number X	Max 24	[105 - 108]	Max 24 ASCII bytes
64977 – FMS Standard interface	28	14	SW-version supported X	4	109	4 ASCII bytes (Version format – ab.cd)
	29	15	Diagnostics supported X	1	110	0-3 0 = diagnostics is not supported 1 = diagnostics is supported 2 = reserved 3 = don't care
	30	16	Requests supported X	1	111	0-3 0 = request is not supported 1 = request is supported 2 = reserved 3 = don't care
65217 - High Resolution Vehicle Distance	31	17	High resolution total vehicle distance X	4	112	0 - 21055406 km*
65216 - Service Information	32	18	Service distance	4	113	-160 635 – 167040 km*
65132 - Tachograph	33	19	Vehicle motion X	1	114	0 – Motion Not Detected 1 – Motion Detected
	34	20	driver 2 working state X	1	115	0 – Rest 1 – Driver Available 2 – Work 3 - Drive 4 – Error 5 – not available
	35	21	driver 1 working state X	1	116	0 – Rest 1 – Driver Available 2 – Work 3 - Drive 4 – Error 5 – not available
	36	22	Vehicle overspeed	1	117	0 – No Overspeed 1 – Overspeed
	37	23	Driver 1 time rel. states	1	118	0 – Normal 1 – 15min bef. 4,5h 2 – 4,5h reached 3 – 15min bef. 9h 4 – 9h reached 5 – 15min bef. 16h 6 – 16h reached 7 – Error 8 – not available
	38	24	Driver 2 time rel. states	1	119	0 – Normal 1 – 15min bef. 4,5h 2 – 4,5h reached 3 – 15min bef. 9h 4 – 9h reached 5 – 15min bef. 16h 6 – 16h reached 7 – Error 8 – not available
	39	25	Driver 1 card X	1	120	0 – Card Not Present

						1 – Card Present
	40	26	Driver 2 card X	1	121	0 – Card Not Present 1 – Card Present
	41	27	Direction indicator	1	122	0 – Forward 1 – Reverse
	42	28	Tachograph performance X	1	123	0 – Normal Performance 1 – Performance Analysis
	43	29	Handling information X	1	124	0 – No Handling Information 1 – Handling Information
	44	30	System event X	1	125	0 – No Tacho Event 1 – Tacho Event
	45	31	Tachograph vehicle speed X	2	126	[0 – 65000] – Tacho Vehicle Speed km/h*
65262 - Engine Temperature 1	46	32	engine coolant temperature X	1	127	[-40 – 210] oC – Engine Coolant Temperature*
65269 - Ambient Conditions	47	33	Ambient Air Temperature X	2	128	[-273 – 1770]oC – Ambient Air Temperature*
65131 - Driver's Identification	48	34	Driver 1 Identification	32	129,130,131	24 ASCII Bytes per Driver ID
65131 - Driver's Identification	49		Driver 2 Identification X	32	132,133,134	24 ASCII Bytes per Driver ID
65266 – Fuel Economy	50	35	Fuel rate X	4	135	[0 – 3212,75] litres/h*
	51	36	Instantaneous Fuel Economy X	4	136	[0 – 125.5 km/litre]*
64932 - PTO Drive Engagement	52	37	At least one PTO engaged	1	137	0 – No PTO Drive is Engaged 1 – At least one PTO drive is engaged 2 – Error 3 – not available
64777 - High Resolution Fuel Consumption (Liquid)	53	38	High resolution engine total fuel used	4	138	[0 - 4211081,215] litres*

13 USING TACHOGRAPH

FM6320 device can read tachograph data. To read older version Tachographs data in addition might need to use special KLN-200 adapter. Tachograph version is too old if FM6320 can't read tachograph data using FM63XX Configurator (CAN-> Auto CAN). Only when this happens necessary to use special KLN-200 adapter. Please contact to your local sales representative for more information.

User can connect FM to vehicle unit tachograph device. Supported devices are: Siemens VDO (DTCO 1381). To read data from K-Line tachograph KLN-200 adapter (K-Line to RS232 converter) must be used. Fig. 1. shows the principal connection scheme.

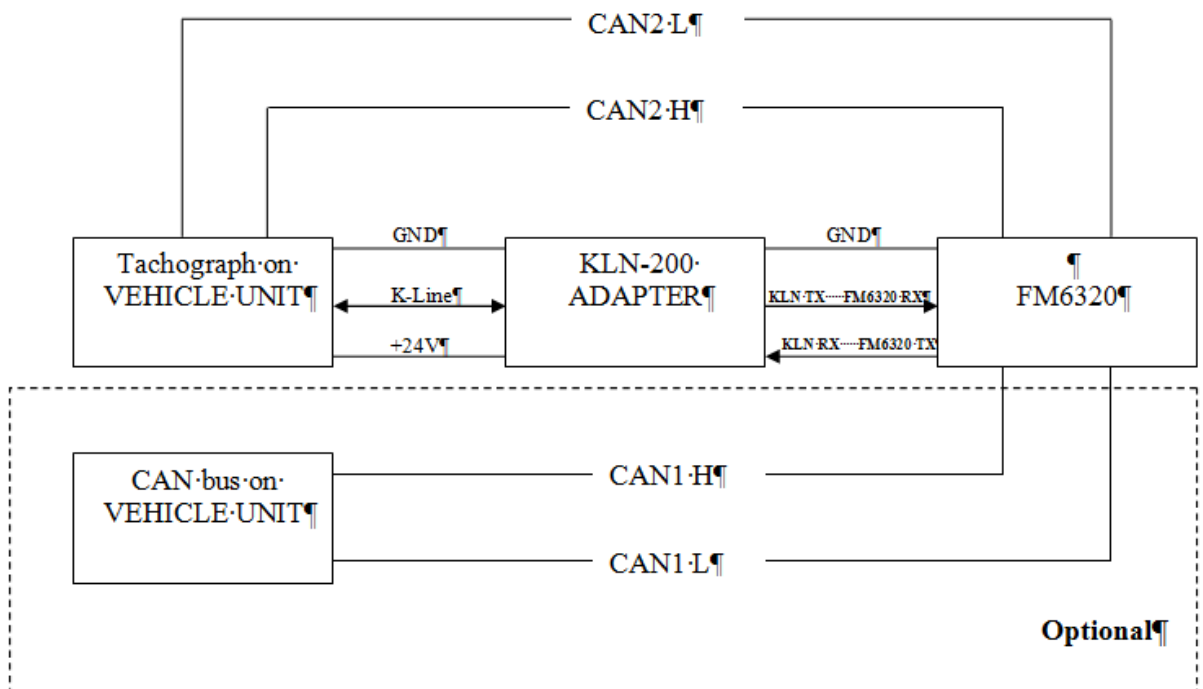

Fig. 1 KLN 200 connection

1.1 KLN-200 Adapter connection

KLN-200 adapter is used for connecting digital tachograph with FM6320.



Fig. 2. Adapter connection



Fig. 3. Adapter case

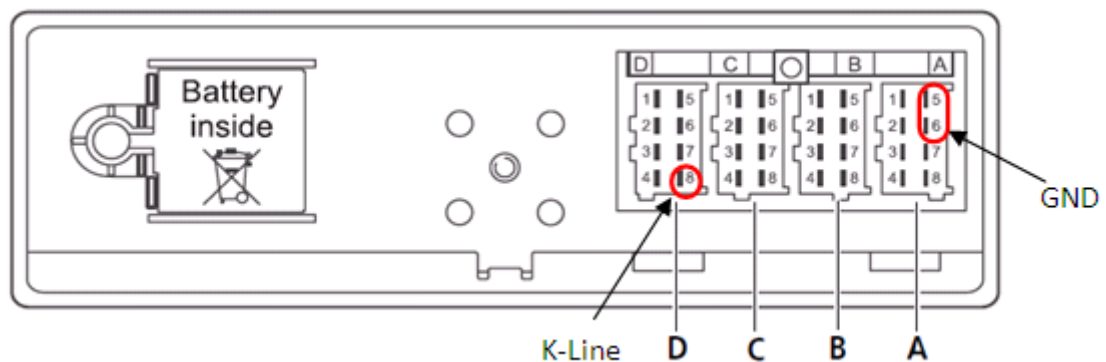

Fig. 4. Tachograph connection

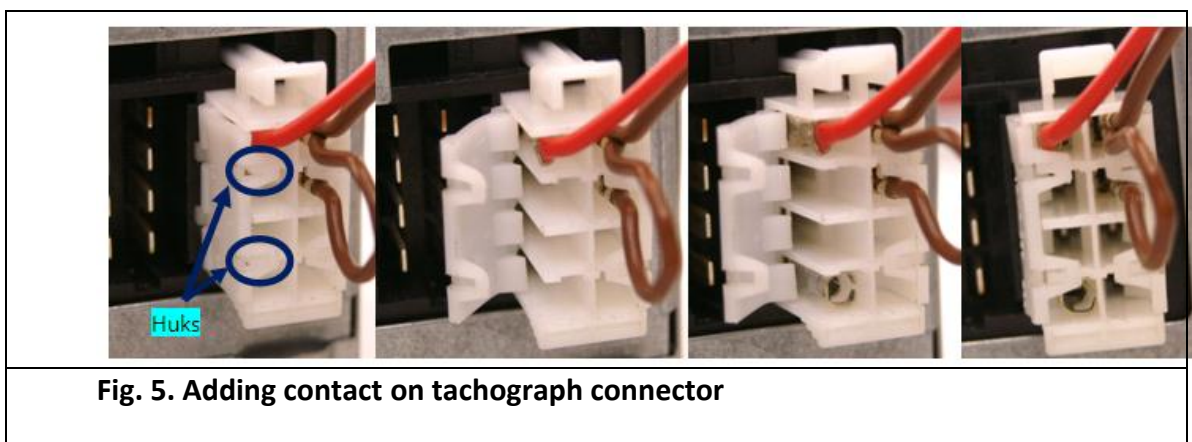

Fig. 5. Adding contact on tachograph connector

- Tachograph D8 and adapter K-Line connectors connected directly.
- Tachograph mounted on vehicles does not have D8 contact. In order to add it, you have to undo the hooks and add the contacts (Fig. 5). Contact code in Farnell system: 925596-1.
- Direct GND connection is required only if vehicle and tachograph grounds are not merged. (It can be checked using multimeter. Connection between different grounds should be 0 volts)
- Adapter power line +24V DC should be connected to constant power supply.
- FM unit and KLN-200 adapter should be connected using Port1/2 cable (cable is available with FM devices).
- KLN-200 adapter has special mounting points (refer to fig. 3).
- LED indication lights up to show adapter activity.
- For contact pressing on KLN-200 it is recommended to use VOGT 3974n or similar pliers.
- For contact pressing on Tachograph it is recommended to use VOGT 3988n or similar pliers.

Each described Vehicle Data element is packed to standard AVL packet and sent to server. Parameter values are sent depending on configuration element ID that are described in „K LINE ID“ column (IO parameter ID).

Vehicle data configuration window (Fig. 7) can be opened by selecting “K Line” in the Configurator. There is the list which holds all elements, each one can be selected by ticking to its name.

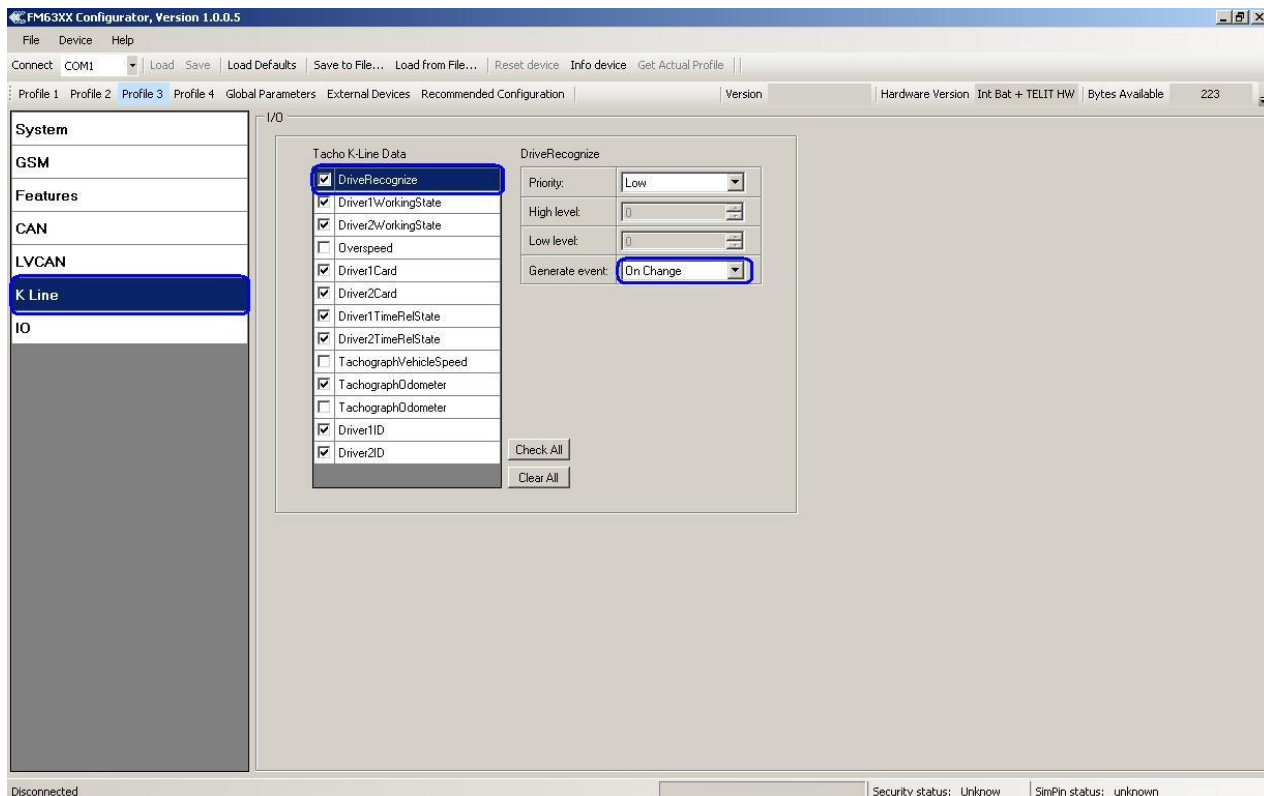

Fig. 7. Vehicle data configuration window

Element configuration (Fig. 7) shows selected element name (marked in red). By selecting other element name will change that way indicating which element is configuring. Priority: low and high. High, low level can be selected only by “Tachograph vehicle speed”, it depends on generate event selection which have “On change” and “Monitoring” modes, “Tachograph vehicle speed” has all (on exit, on enter, on both, hysteresis, monitoring, on change) modes.

To reduce GPRS traffic we recommend using default settings (most I/O elements should be generated “on change”)

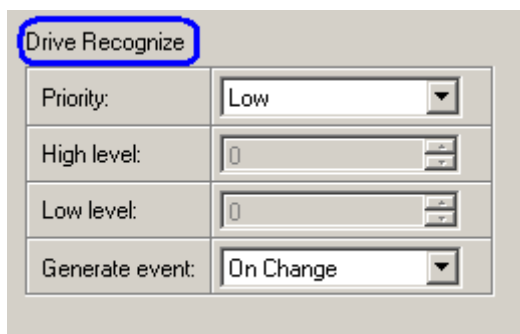

Fig. 8. Vehicle data configuration window

Below configuration available byte size in record is shown, by selecting elements its decreasing and when reaches zero no more elements could not be selected.

Driver 1 ID and Driver 2 ID Tachograph data elements are packed to standard AVL packet and send to server dependent on configuration with element ID described in „K LINE ID“ column. Note that driver ID is 16 bytes long. For this reason it is split to 2 IO elements. On the server side it is required to merge those two IO elements to have full driver ID for whole 16 bytes.

It is also possible to configure Vehicle Data element described in 13.1 table using SMS or GPRS according to basic FM functionality.

Configuration with SMS can be done using two SMS commands: setparam and getparam – standard FM6320 commands for setting and reading parameters. In table 25 it is described all available configuration parameters. Example:

- opa opa setparam 31000 1
- opa opa getparam 31000

14 RFID

Radio-frequency identification (RFID) is the use of a wireless non-contact system that uses radio-frequency electromagnetic fields to transfer data from a tag attached to an object, for the purposes of automatic identification and tracking. FM6320 can be configured in a way to use with an RFID reader. When an RFID of some sorts (typically a plastic card with a magnetic line) is used with an RFID reader which is connected to FM6320, the device creates a record with the data that the RFID reader has read and can be sent to a server with all other information. RFID ID is activated like an I/O parameter (Figure 64).



Figure 64 RFID I/O parameter

To set up FM6320 so it can be connected to an RFID reader, Global parameters have to be set up. Go to external devices and set up COM2 settings to RFID Mode or RFID MF7 Mode (the used mode depends on the mode that the RFID reader works). See Figure 65. The Baudrates for each mode are:

- RFID Mode – 57600
- RFID MF7 Mode – 9600

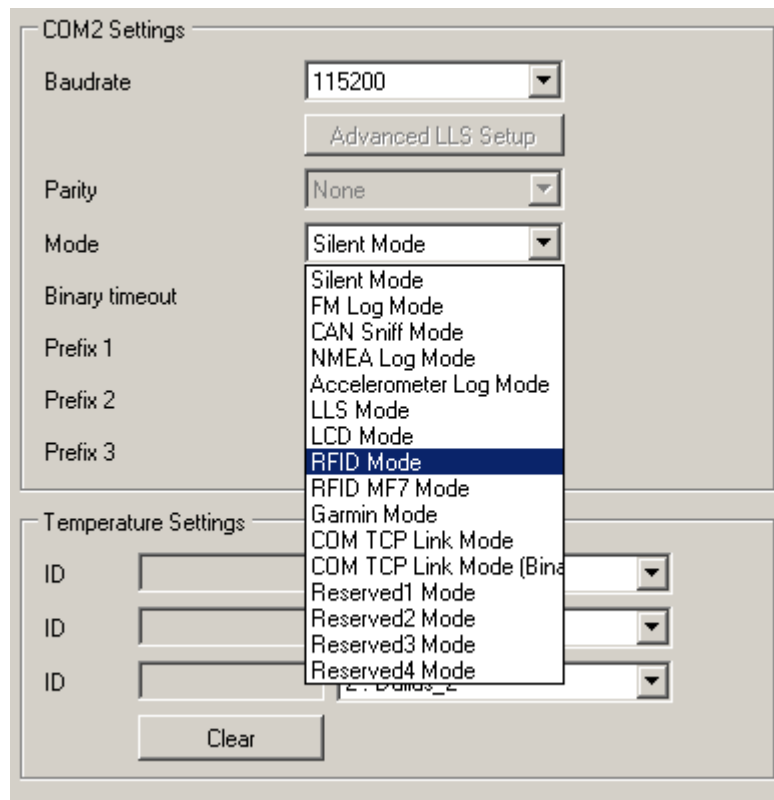

Figure 65 RFID Global parameter settings

The difference between RFID Mode and RFID MF7 Mode is that in RFID Mode FM6320 understands RFID messages that are in hexadecimal format and RFID MF7 Mode understands messages that are in decimal format. For example:

RFID Mode message – “\$aa\$02\$03\$04\$17\$89\$00\$01”

RFID MF7 Mode message – “1213141519”

The chosen mode has to correspond to the RFID reader’s mode. What type of RFID is sent to FM6320 depends on the reader.

For more information about RFID ID’s and devices, please contact to your local sales representative.

15 GARMIN

Garmin provides a Fleet Management Interface Tool Kit which connected to FM6320 enables the driver to have a "screen" in their vehicle for real-time navigation, messaging, and job dispatch capabilities to help them be more efficient.

FM6320 and Garmin operational scheme is shown in Figure 66 below:

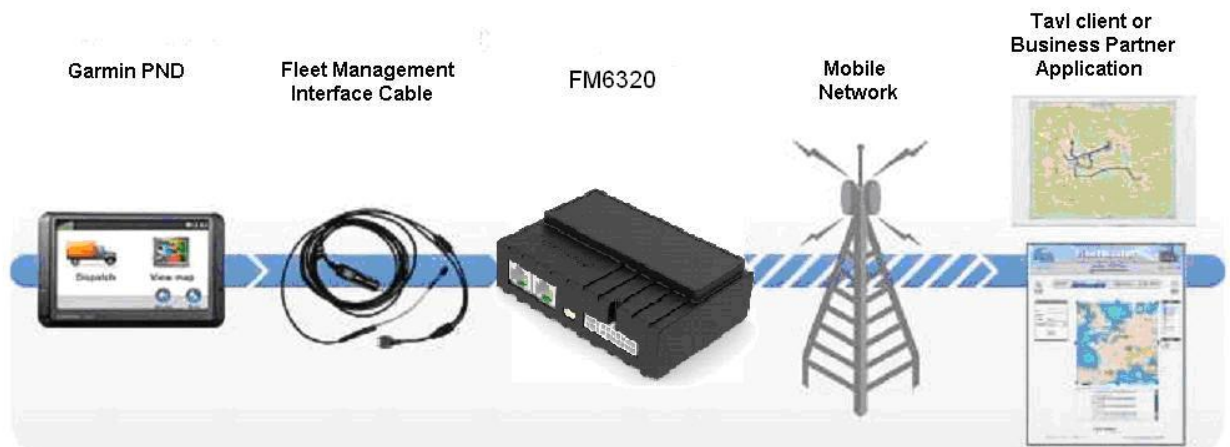

Figure 66 FM53+Garmin operational scheme

15.1 Supported Garmin FMI Protocols

The following is a list of protocols supported and the corresponding feature/benefit. FM6320 can fully support Fleet Management Interface (FMI) versions up to 2.1. Other or higher versions may be supported, but Teltonika is not responsible for the changes made by Garmin, which may affect the work of FM6320 and Garmin products. For more information about Garmin products and FMI versions, please go to <http://www8.garmin.com/solutions/pnd/supportedproducts.jsp>. Notice that some Garmin products use different connection cables than others.

Standard protocols

Text Message Protocol:

- Allows text messages sent to device to be displayed in "inbox" on unit.
- Garmin can provide confirmation that message was read.
- Garmin can also provide a yes/no box below the text of the message to enable a simple quick response.
- Messages can be up to 199 characters in length.
- Messages can also be generated from device and sent to dispatch/office.
- Messages received will be notified to driver through a pop-up alert on Garmin screen.
- Garmin provides a "virtual keyboard" on device through a touch-screen format for all text communication.

Stop (Destination) Protocol:

- Garmin can display a list of Stops/Jobs reported to the device in a separate icon called "My Stops".
- Driver has ability to navigate directly to Stop from list.
- Garmin can provide status on current Stop in progress.
- Is driver stopped at location?
- How far has Driver progressed through the list of Stops?
- Garmin can also provide confirmation that driver has received a particular Stop, read the details, or deleted it from list.

- Can provide confirmation that a Stop has been completed.

Estimated Time of Arrival Protocol:

- Dispatcher/office can request the ETA of the current stop/job in progress.
- Garmin will notify the actual time of arrival as well as distance remaining to stop.

Auto-Arrival at Stop Protocol:

- This feature is used to tell the Garmin PND to automatically detect that it has arrived at a Stop and then to prompt the driver if they would like to mark the Stop as done and begin navigating to next Stop on the list.
- Auto-arrival can be determined by how long the unit is stopped close to the destination (in the event driver has to park and walk) or by how close the unit needs to be to the destination before the Auto-arrival feature is activated.

Data Deletion Protocol:

- Dispatch/office has the ability to wipe clean the data on the Garmin PND.
- Clean up messages in inbox/remove stops.

Enhanced protocols

Canned Responses/Messages:

- Fleet managers can communicate by sending up to 200 "canned" responses from server to be stored directly on Garmin devices.
- Up to 50 of these canned responses can be utilized for any given scenarios.
- Drivers can store up to 120 canned messages, eliminating the need to type while driving.

Status Protocol:

- Up-to-the-minute communications that allow drivers to automatically send status updates.
- Driver's units can store up to sixteen status indicators such as start/stop shift, on/off break, etc.

15.2 Supported features on Tavl client application

Tavl client application lets user to use the following features of GARMIN FMI:

1. Text messaging.
2. Destination message.
3. ETA request.

15.3 Text messaging

Text messaging feature lets user to communicate with driver (user that uses Garmin device) by sending text messages via GPRS.

15.4 Destination message

Destination message is used to inform a driver of a new destination. When Garmin device receives a destination message from server it displays it as "Stop" to the driver and also gives the

driver ability to start navigating to the “Stop” location. New destination in Tavl client is represented as Geozone so new Geozone (as destination) has to be created first.

15.5 ETA request message

ETA (Estimated Time of Arrival) request message is used when user wants to know expected arrival time to currently active destination and distance (in meters) from current object location to currently active destination.

15.6 Connection and pinout

FM5300 RJ-45 (Female)	
Pin Nr.	Description
1	
2	
3	
4	GND (Black wire)
5	Tx (Yellow wire)
6	Rx (White wire)
7	
8	

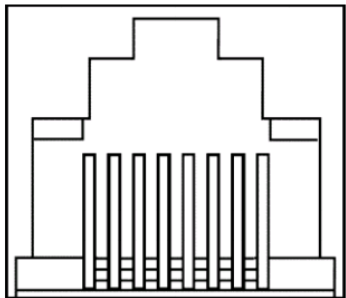

Figure 67 RJ45 Pinouts

In order to connect Garmin PND to FM6320, Garmin mode has to be set in Global parameter settings (figure 65). Simply choose Garmin mode in COM2 settings mode, but you cannot activate Garmin mode in both ports at the same time.

FM6320 is able to filter out some of Garmin FMI packets that are not used in some applications (including Tavl system) and generates additional data transfer at the same time increasing bills of GSM services. In order to enable Garmin FMI Ping Packet Filtering set this feature from Global parameters at the bottom – enable Garmin Ping setting (see Figure 69).

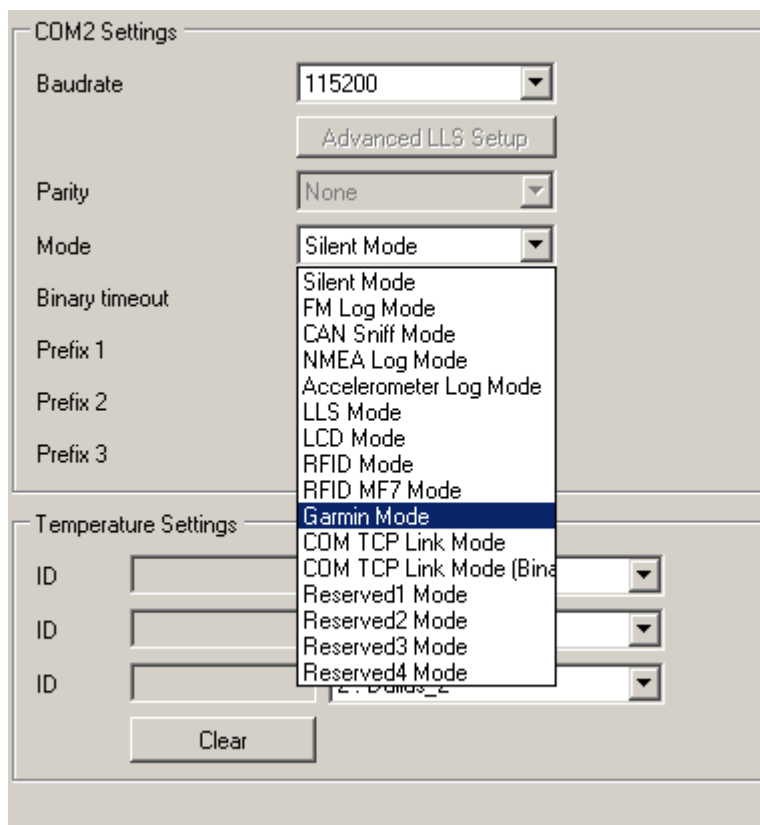

Figure 68 Configuration of Garmin in Global parameter settings



NOTE: Garmin FMI protocols are supported only in TCP data transfer mode.



Garmin Fleet management Interface documentation can be downloaded from Official Garmin web page: http://developer.garmin.com/download/FMI_v2-5.zip.

Software version updates: <http://www8.garmin.com/support/download.jsp>.

For more information about Garmin PND device connectivity to FM6320 and additional information, please contact to your local sales representative.

16 LLS SENSOR

LLS sensor series liquid level sensors are solid-state capacitive devices with no moving parts. The sensors use capacitive technology to produce accurate liquid level measurements of standard factory grade DIESEL OIL and PURE GASOLINE (BENZINE) carbon fuels.

The LLS sensor liquid level sensors are strictly prohibited to use in any liquids which are not the factory grade carbon fuels or contain: BIOFUEL, METHANOL, ETHANOL, UREA and similar aggressive components in pure form or as additives for factory grade carbon fuels for use in INTERNAL COMBUSTION ENGINES. Operating media – Diesel fuel (oil), pure gasoline (benzene).



IMPORTANT!

The power supply is 10-50 VDC stabilized. The wrong polarity (-) or (+) connection of power supply will damage or destroy the device. Prohibited for test or use in water and any other liquids, which are not factory grade carbon fuels. Fit the plastic insulation cap on the end of the central rod after installation accordingly to installation guide. To be installed, calibrated, tested only by qualified authorized person (installer, technician, mechatronic).

16.1 Specifications

Supply voltage, DC V	10...50*
Current consumption, mA (for 12/24 V)	25/50
Operation temperature, Celsius degrees	-40...+85
Working mode	continuous
Weight, kg	< 2.0
Working pressure	atmospheric

16.2 Hardware

- Operation principle: capacitive.
- Output: RS-232.
- Standard probe lengths: 700, 1000, 1500 mm.
- Optocoupler isolation on both power and signal circuits.

16.3 Connecting LLS to FM6320

In order to use LLS fuel counter the newest firmware version is needed which can be obtained from Teltonika or a representative. Firmware is updated over GPRS or using cable update method (see chapter 4 for more information).

The LLS fuel sensor must be connected to the FM6320 device. The FM6320-LLS fuel sensor schemes are shown below Figure 69.

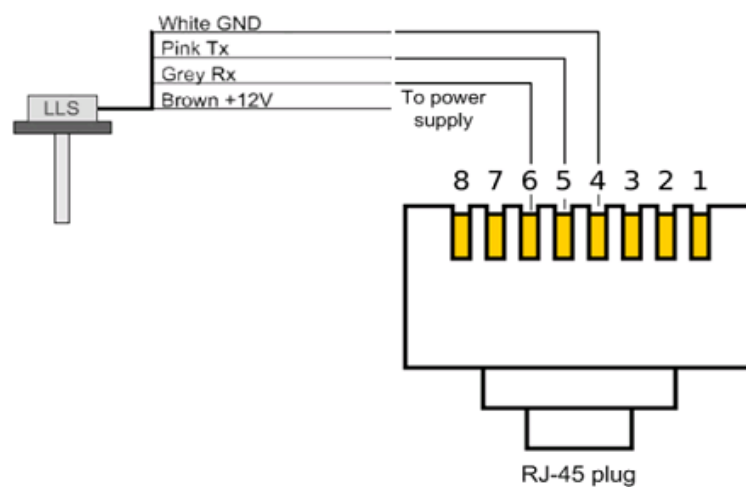

Figure 69 FM6320-LLS fuel sensor connection scheme RJ-45 male plug

*Teltonika is not responsible for any changes made by the manufacturer, which is not declared in fuel level sensor documentation.

Then FM6320 must be configured. Both fuel level and fuel temperature has to be set up by configurator's I/O menu (see Figure 70):

LLS #1 Fuel	<input checked="" type="checkbox"/>	Low	0	0	Monitoring	10
LLS #1 Temperature	<input checked="" type="checkbox"/>	Low	0	0	Monitoring	10
LLS #2 Fuel	<input checked="" type="checkbox"/>	Low	0	0	Monitoring	10
LLS #2 Temperature	<input checked="" type="checkbox"/>	Low	0	0	Monitoring	10
LLS #3 Fuel	<input checked="" type="checkbox"/>	Low	0	0	Monitoring	10
LLS #3 Temperature	<input checked="" type="checkbox"/>	Low	0	0	Monitoring	10
LLS #4 Fuel	<input checked="" type="checkbox"/>	Low	0	0	Monitoring	10
LLS #4 Temperature	<input checked="" type="checkbox"/>	Low	0	0	Monitoring	10
LLS #5 Fuel	<input checked="" type="checkbox"/>	Low	0	0	Monitoring	10
LLS #5 Temperature	<input checked="" type="checkbox"/>	Low	0	0	Monitoring	10

Figure 70 FM6320 I/O Configuration

17 GPRS COMMANDS

It is possible to send commands to FM6320 using GPRS. When FM6320 sends records periodically to a server, a message could be sent from the server and FM6320 will reply to it. FM6320 has to be connected to the server in order to receive commands.

Command	Description
#GET DATAORDER	Get info about records sorting parameter
#SET DATAORDERX=Y	Set records sorting parameter, X – profile, Y – value (0/1).
#GET RECTO	Get info about records refresh timeout parameter
#SET RECTO=X	Set records refresh parameter, X = records refresh timeout
#GET VERSION	Receive firmware version
#GET NETWORK	Get GSM operator to which device is connected
#GET IMSI	Get IMSI of the device
#GET OUT	Get DOUT values
#DO REPORT	Save a record
#DO RESET=XXX	Reset FM6320 or GPS module, XXX – FM5X or GPS
#GET ROAMINGX=Y	Get operator from the list of a certain profile, X – profile, Y – operator number in a list
#SET ROAMINGX=Y,Z	Set operator to the list of a certain profile, X – profile, Y – operator number in a list, Z – operator code
#GET REMIPX	Get IP and port number from the configuration of a certain profile, X – profile
#SET REMIPX=Y:Z	Set IP and port number to the configuration of a certain profile, X – profile no, Y – IP or domain, Z – port number
#GET AUPX	Get APN, user login and password from the configuration of a certain profile, X – profile
#SET AUPX=Y,Z,W	Set APN, user login and password to the configuration of a certain profile, X – profile, Y – APN, Z –, user login W - password
#GET REPRTX	Get MinPeriod from the configuration of a certain profile, X – profile

#SET REPRTX=Y	Set MinPeriod to the configuration of a certain profile, X – profile, Y – MinPeriod value
#GET REPDISTX	Get MinDistance from the configuration of a certain profile, X – profile
#SET REPDISTX=Y	Set MinDistance to the configuration of a certain profile, X – profile, Y – MinDistance value
#GET REPANGX	Get MinAngle from the configuration of a certain profile, X – profile
#SET REPANGX=Y	Set MinAngle to the configuration of a certain profile, X – profile, Y – MinAngle value
#GET SENDPERIODX	Get SendPeriod from the configuration of a certain profile, X – profile
#SET SENDPERIODX=Y	Set SendPeriod to the configuration of a certain profile, X – profile, Y – SendPeriod value
#GET REPMRX	Get MinRecords from the configuration of a certain profile, X – profile
#SET REPMRX=Y	Set MinRecords to the configuration of a certain profile, X – profile, Y – MinRecords value
#GET IBTNX=Y	Get iButton value from the configuration of a certain profile, X – profile, Y – number on the list
#SET IBTNX=Y,Z	Set iButton value to the configuration of a certain profile, X – profile, Y – number on the list, Z – iButton value
#GET EXTERR	Get extended errors value
#SET EXTERR=X	Set extended errors value, X – 0/1

There is also a possibility to send the same messages as in SMS command list (chapter 11). The device sends a response to every command received.

Command	Description
getstatus	Modem Status information
getweektime	Current device time, Day of Week and amount of minutes passed since start of week
getops	List of currently used and available GSM operators
readops#	Emergency gsm operator readout from active profile # - 1,2,3 1 – operators [1-20] 2 – operators [21-40] 3 – operators [41-50]
getnmeainfo	Nmea error debug sms
getcfgtime	Date and Time of last successful configuration
getgps	Current GPS data and time
loadprofile#	Load specified profile into RAM Engine Profile. # - number of profile to load
cpureset	Reset CPU
resetallprof	Reset all FLASH profiles to default profile
getver	Device / Modem / Code version information
getinfo	Device runtime system information
deleterecords	Delete all records saved on FLASH
getio	Readout digital inputs and outputs, analog inputs
radio #	Readout input value according entered ID, # - ID value

setdigout XXXX Y1 Y2 Y3 Y4	Set digital outputs 0 – OFF, 1 – ON Y1 – timeout for DO1 Y2 – timeout for DO2 Y3 – timeout for DO3 Y4 – timeout for DO4
getparam #	Readout parameter value according entered ID. # - ID value.
setparam # #	Set parameter value according entered ID and Value. 1.# - ID value. 2.# - New Parameter Value
flush #,#,#,#,#,#	Initiates all data sending to specified target server 1.# - IMEI 2.# - APN 3.# - LOGIN 4.# - PASS 5.# - IP 6.# - PORT 7.# - MODE (0-TCP/1-UDP)
sn x [x=0;1]	Enable/disable static navigation
banlist	Banlist information
crashlog	Crash log information
delete_all_sms	Delete all read SMS
braminfo	BatRam info
getgnss	Current GNSS information
resetlimits	Resets data counters



ATTENTION!

In order to send these commands, they have to be converted to special format. How to convert to this format and for additional information on how to send GPRS commands, please contact to your local sales representative.

18 DEBUG MODE

FM6320 is able to transmit its current state when connected to PC using PORT1/2 and USB cable. To debug FM6320 with USB cable, in terminal you should set high level to DTR pin. It is used to detect errors and provide information to possible solutions when operating as unexpected. Contact our sales manager to get Terminal. After launching it choose baud rate 115200 and hardware control – none. Click on ‘Start Log’ button and save a new file. Then click ‘Connect’ to start receiving messages from FM6320 (see Figure 71).

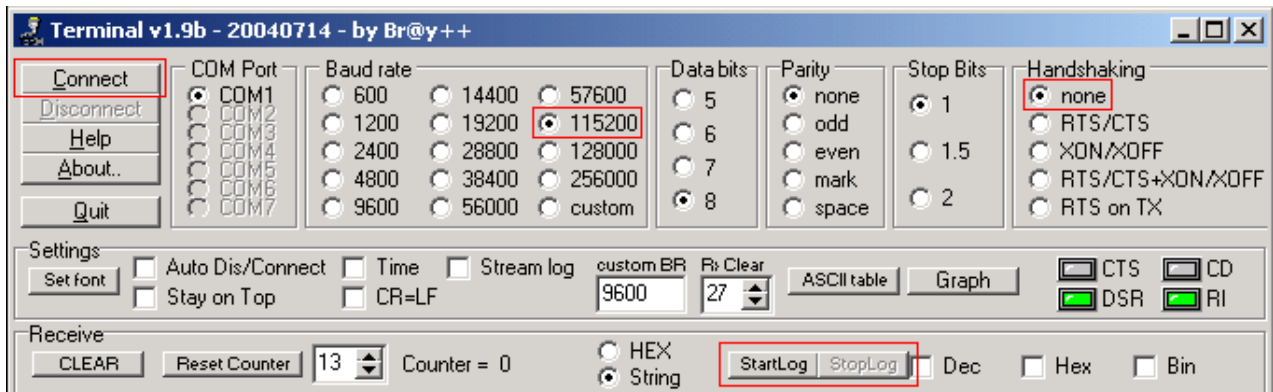

Figure 71 Terminal Window

To debug NMEA GPS data, connect PORT3 cable to COM2 port, or connect PORT2 cable and enable nmea log mode, or via USB cable activating nmea log mode by sending `.log_nmea:1` command in terminal.

19 FM6320 REMOTE LOG

LOG BOOK

Two types of log book: online, offline.

Online log book is initiated using command `log2srv` and set right configuration. Device establish GPRS connection and activates link to server, log started to stream to server until set time is elapsed. To stop streaming immediately `log2srvstop` is used.

Offline log book is initiated using command `log2srv` and set right configuration. Device start log writing to flash, this action is performed until set time is elapsed.

To read offline log `log2srvstart` command is used. It sends log to earlier preconfigured server (`log2srv`). Offline log sending also can be terminated using `log2srvstop` command.

COMMANDS

- `"SMSlogin<space>SMSpassword<space>log2srv<space><enable>,<mode>,<APN>,<username>,<password>,<IP>,<port>,<TMO>,<Log mode>"`
 - `<enable>` - enable (1), disable(0);
 - `<mode>` -
 - `silent (0)` – connect to server and send "Hello" message (all "Terminal" commands can be used)
 - `echo_time (1)` – send log with lines, where is TIME "for example: - [2013.1.23 14:49:45]-[PERIODIC.BAN.LIST.INFO]:"
 - `echo (2)` – send log with lines where is no TIME "for example: [DIN1.FUNC]->Waiting for DIN1 to be ON"
 - `echo/echo_time (3)` – send full log
 - `modem (4)` – send just AT commands

- NMEA (5) – send NMEA log.
 - <APN> - operators' APN which will be used for data sending;
 - <username> - operators' username;
 - <password> - operators' password;
 - <IP> - servers' IP address to which offline/online log will be send after request ("log2srvstart");
 - <port> - servers' port;
 - <TMO> - indicates time of offline log writing to flash or online log sending to server;
 - <Log mode> - configuration for online mode (0), configuration for offline mode (1);
- "SMSlogin<space>SMSpassword<space>log2srvstart"
- "SMSlogin<space>SMSpassword<space>log2srvstop"

Example: opa opa log2srv 1,3,banga,,,212.47.99.62,7092,300,0



Note: Up to 5 minutes delay could appear if wrong "log2srv" commands settings will be sent, during that time no SMS or GPRS command could be received. SMS will be hanging, after timeout, hanging SMS's will be proceeded.

DOWNLOADING LOG USING "HERCULES"

1 STEP:

- set special chars – ASCII
- Set PORT and start listen (screen below)

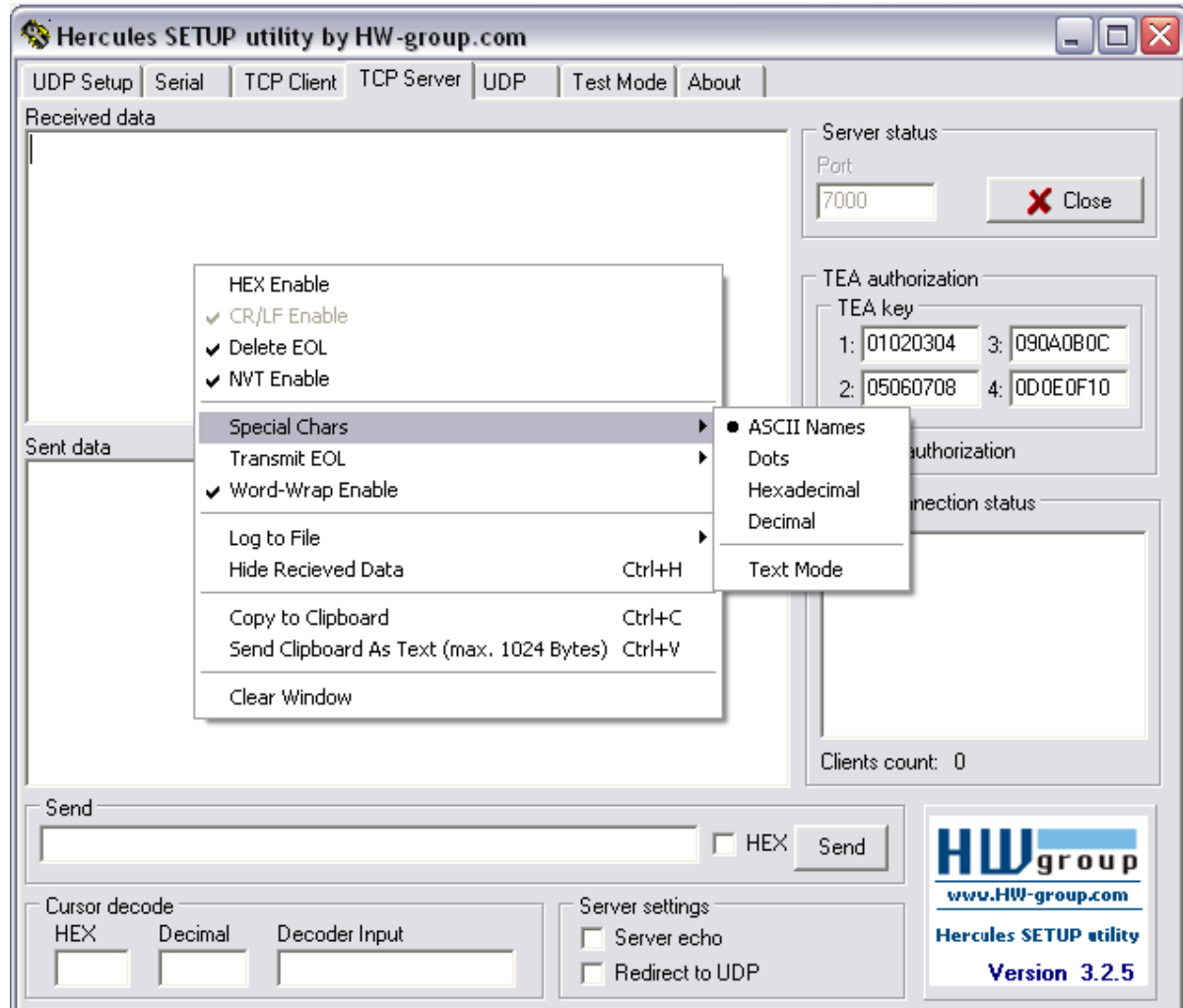

2 STEP

- Set directory for file download
- Enable “Log to file” as show below

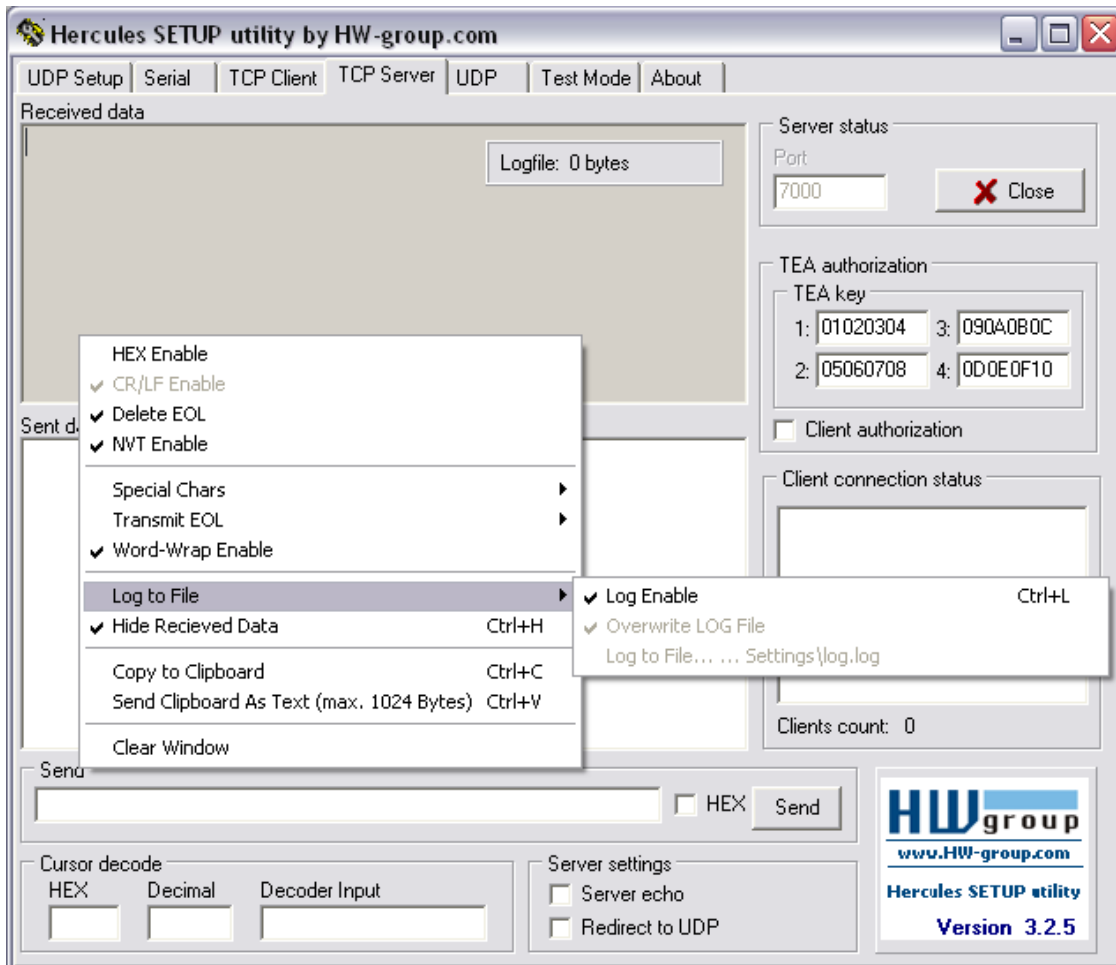

3 STEP

“Terminal” Command sending using Hercules

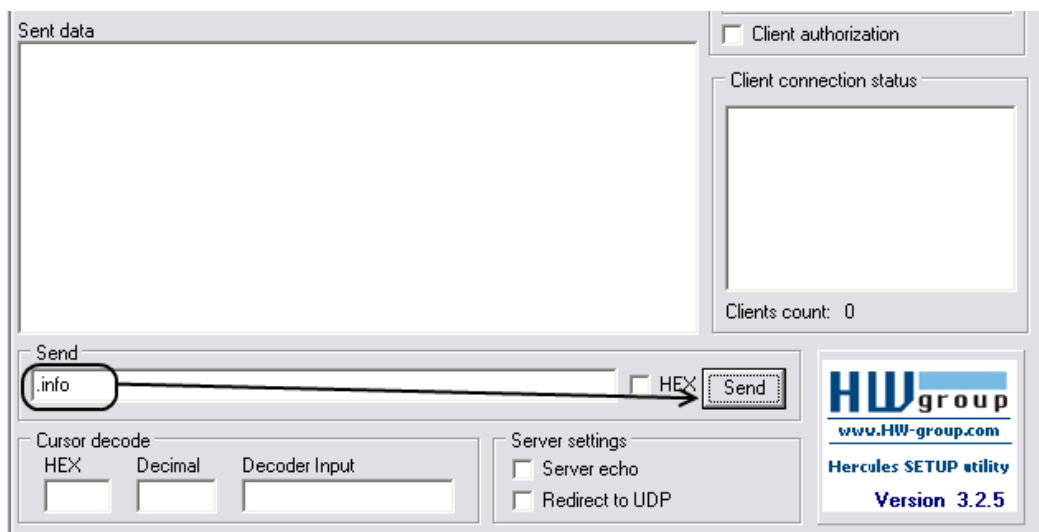

20 CHANGE LOG

Nr.	Date	Version	Comments
1	2016-06-21	v1.01	Changed FM6320 interfaces list, I/O parameters list, all parameters ID, multiple parameters configuration format. Added descriptions to new configurator's tabs.
2	2016-06-21	V1.02	Changed KLN-200 and FM6320 connection to tachograph
3	2016-06-22	V1.03	Changed KLN-200 figure, fixed information about interfaces, changed accelerometer updating frequency, added some references, added examples of SMSevent and WeekTime configuration.
4	2016-07-26	V1.04	Added older tachograph version identification, changed scenarios functionality according to newest modifications.
5	2016-08-22	V1.05	Corrected Virtual COM Port driver download link